

**OPERATING AND
SERVICE INSTRUCTIONS
FOR...**

**COMMUNICATIONS
TRANSMITTER
MODEL HT-44**

the hallicrafters CO.



A Subsidiary of Northrop Corporation

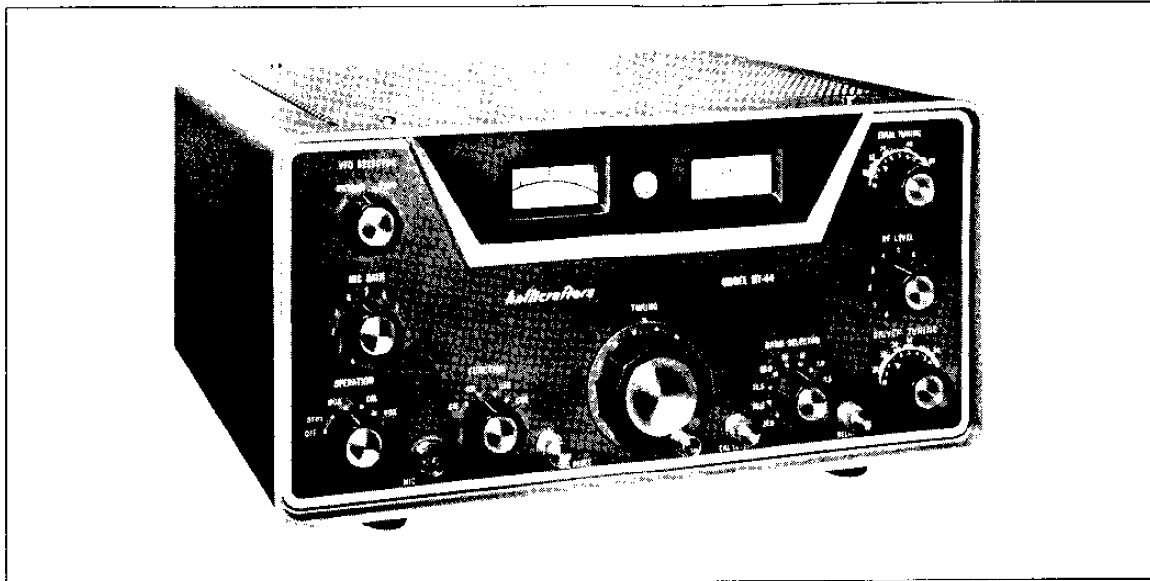

Figure 1. Hallicrafters' Model HT-44 Transmitter/Exciter.

156-002699

SECTION I GENERAL DESCRIPTION

1.1. INTRODUCTION.

The Hallicrafters' Model HT-44 is a seven-tube Transmitter/Exciter capable of SSB (Single Sideband with suppressed carrier), AM (DSB), and CW transmission in the 80, 40, 20, 15, and 10 meter amateur bands. This unit can represent the complete transmitting complement of a station. The only requirements for immediate "on-the-air" operation are a PS-150-120 Power Supply, a 50-ohm terminated antenna system, a key or microphone, and an AC power source.

The unit may be utilized as a complete transmitter, or as an exciter for driving a linear amplifier such as an HT-45, HT-33B, HT-41, or others. If other linear amplifiers are used, they should be capable of supplying a 50-ohm termination for the HT-44.

When used in conjunction with an SX-117 receiver, slave (transceive) operation or independent operation is selectable by a panel switch.

An outstanding feature of the HT-44 is the amplified Automatic Audio Level Control (AALC). The AALC circuitry virtually eliminates splatter commonly caused by excessive audio gain and its resultant "flat-topping." This is accomplished by providing up to 12 DB of compression at the point

where flat-topping would normally occur, assuring maximum talk power while maintaining a clean, sharp signal.

IMPORTANT

See paragraph 6-6, SINGLE SIDEBAND OPERATION, for correct MIC GAIN control setting.

1.2. TVI (Television Interference) SUPPRESSION.

The HT-44 has been designed and constructed to suppress spurious radiations that may cause television interference. The TVI problem was given full consideration in the design and layout of the chassis. Components specifically selected to avoid undesired resonances and arranged to prevent parasitic oscillations have been used.

There are, however, some types of TVI that cannot be prevented within the transmitter itself. This is particularly true in fringe reception areas. In such cases, a good commercial low-pass filter connected at the transmitter output is recommended. For a more complete discussion of measures that may be used to handle special problems of this type, refer to the ARRL HANDBOOK.

SECTION II SPECIFICATIONS

TYPE OF SIDEBAND GENERATION

Phasing at 1650 KC.

TYPES OF EMISSION

SSB: Selectable upper or lower sideband with suppressed carrier.

AM: Double sideband with carrier (amplitude modulation).

CW: Continuous wave.

FREQUENCY SELECTION

Self-contained VFO or slave (transceiver) with SX-117 receiver.

FREQUENCY COVERAGE

80, 40, 20, 15 and four 10 meter segments. 28.5 to 29.0 MC crystal supplied with provisions and crystals available for other 10-meter segments.

MAXIMUM POWER INPUT

CW: 200 watts.

SSB: 200 watts PEP.

POWER OUTPUT

SSB: 100 to 130 watts (PEP).

CW: 100 to 130 watts.

AM: 25 to 35 watts (carrier).

AUDIO INPUT

0.005 volt to high-impedance load.

CARRIER SUPPRESSION

50 DB or more below maximum output.

UNWANTED SIDEBAND REJECTION

50 DB or more at 1 KC. 30 DB or more, 500 to 2500 CPS.

THIRD AND FIFTH ORDER DISTORTION PRODUCTS

30 DB or more.

UNWANTED BEAT OUTPUT

55 DB or more below maximum output.

CW KEYING

Manual or break-in. Rear-mounted jack accepts standard 1/4-inch phone plug. Keying point also provided at control outlet.

DIAL CALIBRATION

5-KC increments (500-KC tuning range).

CALIBRATION ACCURACY

Better than 2 KC between 100-KC check points after indexing.

MICROPHONE INPUT

Panel-mounted receptacle accepts Amphenol 80-MC2M connector (high impedance).

CONTROL METHODS

MOX (manual); VOX (voice control), PTT (push-to-talk), and CW break-in.

RF OUTPUT IMPEDANCE

50 ohms. Rear chassis-mounted receptacle accepts RCA-type phono plug (supplied). Chassis punched to accept Amphenol UHF receptacle.

STATION CONTROL

Rear chassis-mounted eleven-pin socket accepts Amphenol 86-PM11 plug (supplied).

TUBES

Seventeen (including one voltage regulator) plus three semiconductor diodes.

TRANSCIVEIVE CABLE ASSEMBLY

CA-44 (Optional).

POWER SUPPLY

External, remote-control PS-150-120 with receiver speaker built in.

POWER SUPPLY REQUIREMENTS

117 volts, 50/60 cycles, 400 watts.

DIMENSIONS (Overall)

7-3/4 by 14-31/32 by 14-3/4 inches (HWD).

SHIPPING WEIGHT

Approximately 21 pounds (less power supply).

SECTION III INSTALLATION

IMPORTANT

The final amplifier bias must be set before any further checks are made. Failure to do this may cause permanent damage to the final amplifier tubes. (See paragraph 9-3.)

Do not attempt to tune or operate this transmitter without an antenna or dummy load known to be near 50 ohms impedance at the operating frequency.

If removal of the top cabinet cover is desired, turn the four screws approximately one-quarter turn counterclockwise. Do not attempt to remove these screws.

CAUTION

Exposed voltages are present whenever the OPERATION switch is at any position other than OFF. Use extreme care when working on this transmitter with the top or bottom covers removed.

3-1. UNPACKING.

After unpacking the HT-44, examine it closely for any possible damage that may have occurred in transit. Should any sign of damage be apparent, file a claim immediately with the carrier stating the extent of damage. Carefully check all labels and tags before removing or destroying them.

3-2. LOCATION.

This unit should be placed in a location that provides adequate space around it to permit free circulation of air through the cabinet openings. Avoid excessively warm locations such as those near radiators and heating vents.

3-3. POWER SOURCE.

The HT-44 is designed to operate from a PS-150-120 Power Supply. This supply is remotely switched by the HT-44 OPERATION switch and supplies all necessary operating voltages as well as a built-in receiver speaker. All connections, including the speaker, are made by inserting the Jones-type connector into the HT-44.

The PS-150-120 supply is designed to operate from a 117-volt nominal, 50/60-cycle source. Power consumption at 200 watts CW input is 400 watts.

IMPORTANT

If in doubt about your power source, contact your local power company prior to inserting the power plug into any outlet. Plugging the line cord into the wrong power source can cause extensive damage to the unit.

Be certain that the HT-44 OPERATION switch is in the OFF position before connecting the power supply.

3-4. FRONT PANEL CONNECTIONS.

MICROPHONE RECEPTACLE.

A front panel receptacle is provided for the microphone. The microphone cable should be fitted with an Amphenol 80-MC2M connector and wired as shown in figure 2.

Any good high-impedance microphone may be used; however, best results will usually be achieved with a type designed especially for SSB use.

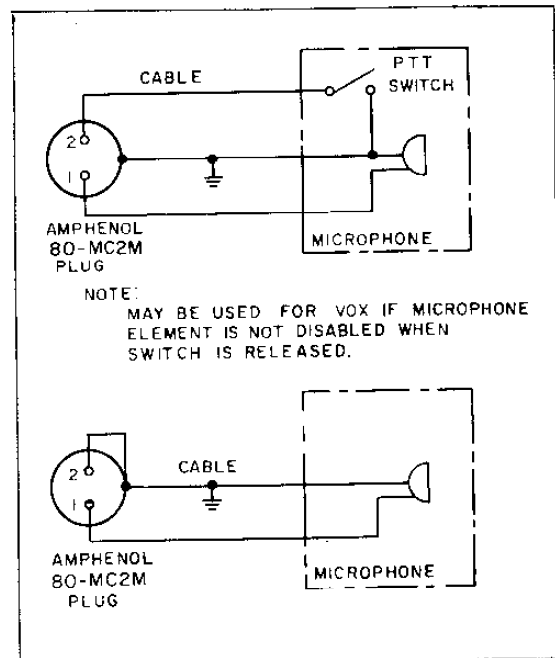

Figure 2. Required Microphone Wiring with and Without Push-To-Talk Switch.

156-002570

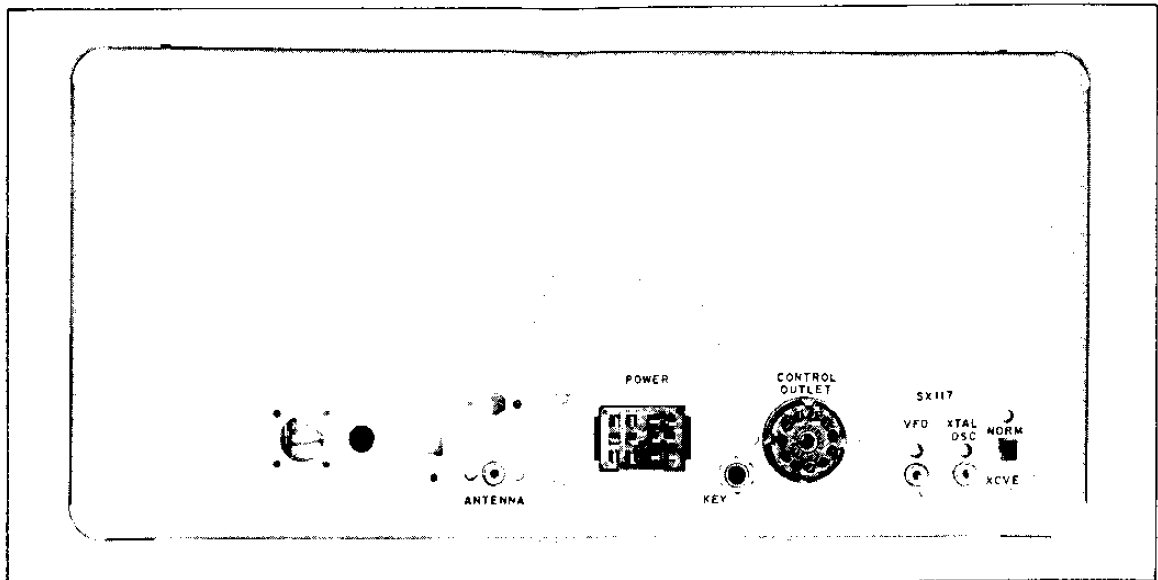

Figure 3. Rear View of Transmitter, Showing Connectors.

156-002624

3.5. REAR CHASSIS CONNECTIONS. (See Figure 3.)

B. RF OUTPUT

A. KEY JACK

A standard closed-circuit phone jack is provided for keying. This jack accepts a standard 1/4-inch phone plug. The plug should be wired so that the key base is connected to the sleeve of the plug which is at ground potential.

A phono-type coaxial receptacle is provided for RF output. The RG-58/U coaxial cable, which normally goes to the transmit side of the antenna changeover relay, should be fitted with an RCA-type phono plug and inserted into this receptacle.

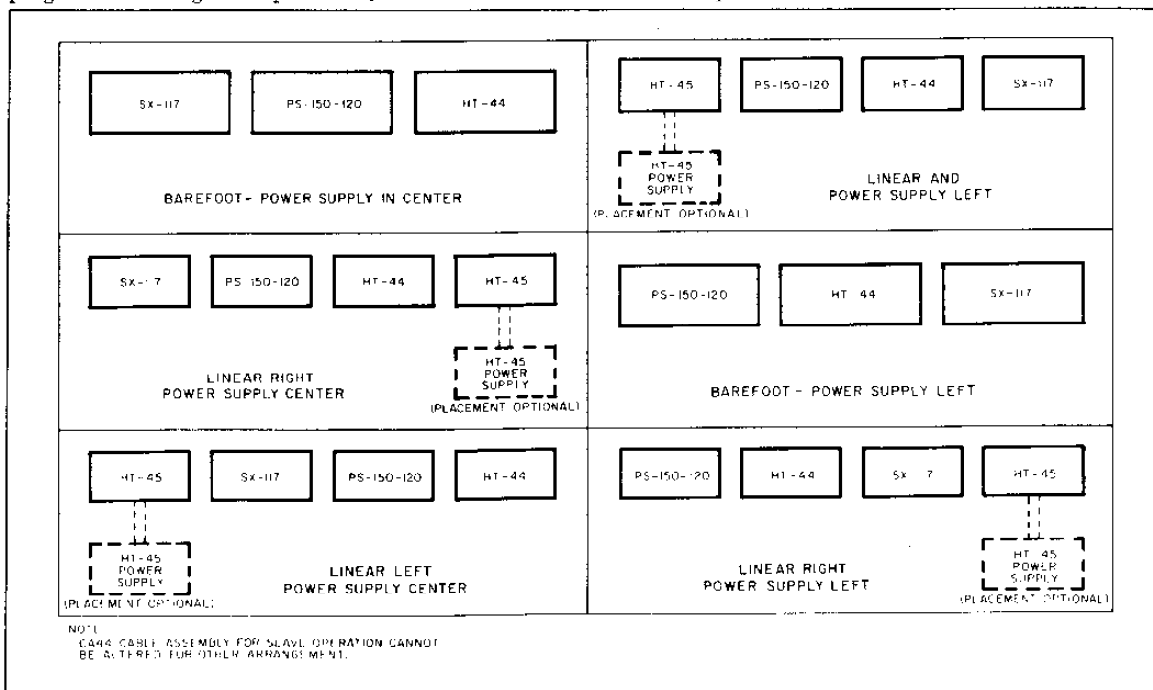

Figure 4. Possible Placement of Units on Operating Desk.

156-002568

The chassis is punched to allow mounting of an Amphenol UHF receptacle if desired. This receptacle should be connected in parallel with the original receptacle through a short length of NO. 18 or 20 AWG tinned copper wire.

The chassis is also punched to allow mounting of an additional receiver antenna receptacle, and an internal antenna changeover relay. It should be noted that this arrangement should be used only if "barefoot" operation is contemplated. It is not required if a linear amplifier will be used. (See Section XI for circuitry and parts list.)

C. CONTROL SOCKET

An eleven-pin socket is provided to connect the HT-44 into the station control system. The mating connector for this socket is an Amphenol 86-PM11 (supplied).

1. Key (Pins 1 and 8)

For CW operation, the key may be connected to pins 1 and 8 of the control socket. Pin 1 is internally grounded and should be connected to the key base. When the key is up, cutoff bias is applied to the second mixer and driver stages. Closing the key removes this bias, providing normal excitation to the final amplifier.

NOTE

A key jack is also provided for this purpose.

2. Anti-Trip Input (Pins 1 and 11)

The application of the receiver audio output to pins 1 (ground) and 11 prevents "nuisance tripping" when operating the transmitter in the VOX mode with a speaker connected receiver. Any normal receiver output impedance may be used for this purpose.

3. Accessory Relay Contacts (Pins 2, 3, 4-5, 9, 10 and 6, 7)

Three independent groups of relay contacts are available for external switching. Two groups are switched by SPDT contacts, and the third by a SPDT with its pole internally grounded to the chassis.

In group 1, the pole is connected to pin 3. Contact will be made between pins 2 and 3 in transmit, and between pins 3 and 4 in receive.

In group 2, the pole is connected to pin 9. Contact will be made between pins 5 and 9 in transmit, and between pins 9 and 10 in receive.

In group 3, the pole is internally grounded. Pin 7 will be grounded in receive and pin 6 is connected to the push to talk line for remote operation (foot switches, etc.). See figures 4 through 6 for typical control systems and equipment arrangement.

D. XTAL OSC - VFO JACKS

These jacks are used in conjunction with the SX-117 for slave operation. See Section VII TRANSCEIVE (SLAVE) OPERATION.

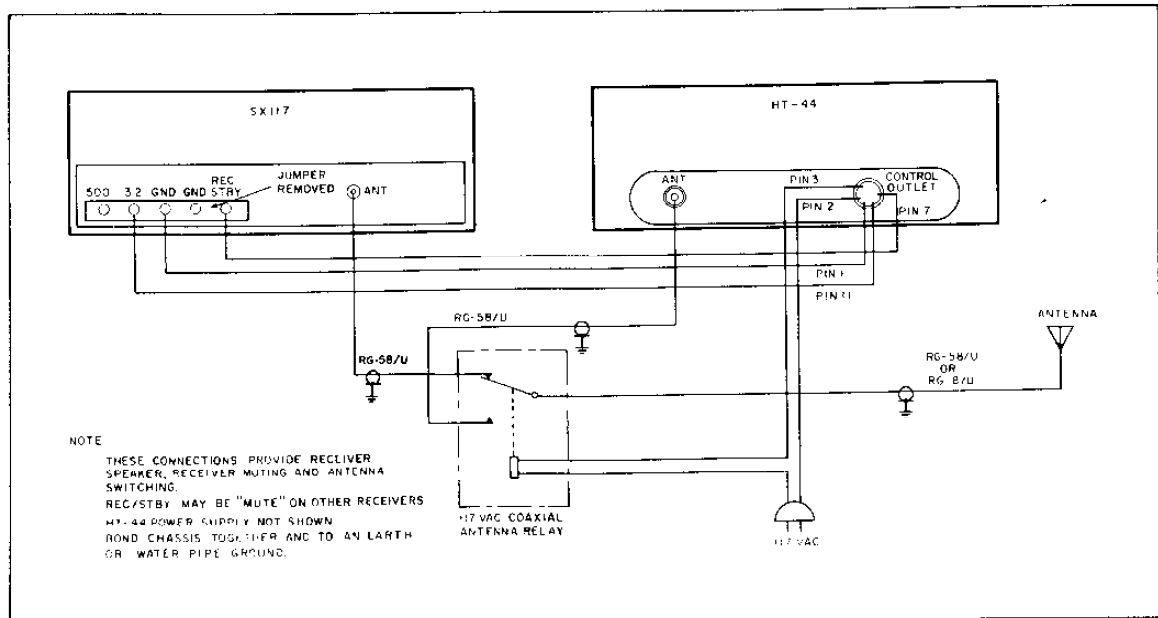

Figure 5. Typical Interconnection for HT-44 and SX-117.

156 002567

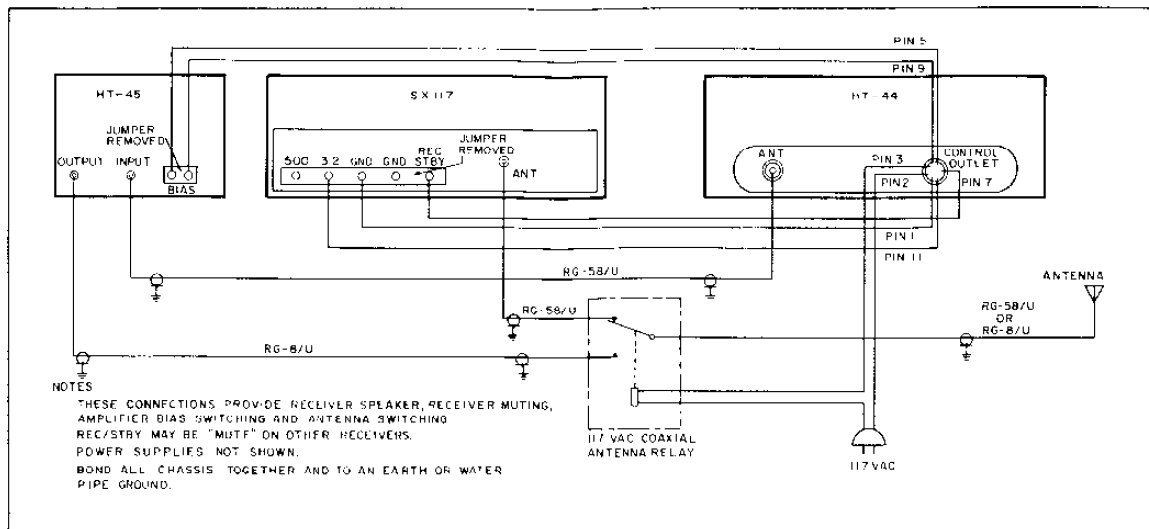

Figure 6. Typical Interconnection for HT-44, HT-45, and SX-117.

156-002566

SECTION IV

FUNCTIONS OF OPERATING CONTROLS

4.1. OPERATION.

This control is a five-position rotary switch which turns on the PS-150-120 Power Supply, places the transmitter in STBY (Standby), and/or selects the mode of operation, MOX or VOX, and CAL.

In STBY, voltages are applied to all circuits, with cutoff bias, to prevent transmitter output.

If manual operation is desired for voice or CW, the switch is rotated to MOX for transmit and to STBY during the receive period. This will actuate all control circuitry in the proper sequence for transmission and reception.

If push-to-talk operation is desired, the switch is left in MOX for both transmission and reception, changeover switching being controlled by the microphone push-to-talk switch.

If automatic operation (voice control or CW break-in) is desired, the OPERATION switch should be rotated to VOX.

For voice operation, automatic switching from standby to transmit will occur by means of voice control.

For break-in CW, switching from standby to transmit will occur automatically when the Key is closed. The transmitter will remain in transmit until the keying is interrupted and then will automatically return to standby.

In the CAL position, a controllable, low-level CW signal is generated for tuning and frequency-calibration purposes. In this position, the VOX relay is inhibited and standby bias is maintained. If an antenna changeover relay is used, the receiver will operate normally so that the transmitter signal can be monitored, and the signal level into the receiver controlled by the CAL. LEVEL control. This allows the transmitter to be tuned exactly to the receiver frequency, when not in transceive, by "zero-beating" the signal.

4.2. FUNCTION.

The FUNCTION control is a four-position rotary switch which selects CW, AM, USB (upper sideband), or LSB (lower sideband) mode of transmission, as desired by the operator.

4.3. BAND SELECTOR.

The BAND SELECTOR control is an eight-position rotary switch which selects the correct crystal, tuned circuits, loading capacity, neutralizing capacity, and gain-equalizing resistance for the desired band. It should be noted that the band-segment dots appear in two different colors so that the correct dial scale may readily be identified.

4.4. TUNING.

The TUNING control rotates a variable capacitor and dial to establish the desired operating frequency within a band segment.

If the BAND SELECTOR is set to 3.5 (red dot), the red dial scale must be used. 500 on the red scale will represent 3500 KC, 600 on the red scale will represent 3600 KC, etc.

If the BAND SELECTOR is set to 7.0 (white dot), the black scale must be used. 0 on the black scale will represent 7000 KC, 100 on the black scale will represent 7100 KC, etc. Follow this color coding for the remaining band segments.

4.5. CAL RESET.

The CAL RESET control rotates a small variable capacitor to provide dial calibration correction, if necessary. This is usually done by "zero-beating" the transmitter against a signal of known frequency, such as a 100-KC crystal calibrator in a receiver. Calibration should be checked at the 100-KC multiple nearest your operating frequency.

If calibration correction is necessary, rotate the CAL RESET control clockwise or counterclockwise as necessary to cause the transmitter dial reading to agree with the output frequency.

4.6. CAL LEVEL.

The CAL LEVEL control provides a low-level adjustment of the transmitter output when the OPERATION switch is set at CAL. The CAL LEVEL control is normally set to provide the desired signal level in the station receiver for monitoring purposes and need not be changed except possibly when changing bands. Regardless of the setting of the FUNCTION switch, a carrier signal is obtained for "zero-beat" frequency setting. Note that when in the calibrate mode, the RF LEVEL control has no effect on the transmitter output.

4.7. RF LEVEL.

The RF LEVEL control is a potentiometer in the output circuit of the balanced modulators which in CW and AM varies the carrier output of the modulator. In USB or LSB (suppressed carrier), this control has no effect.

4.8. DRIVER TUNING.

This is a two-section variable capacitor used for resonating the second mixer and driver

plate coils to the desired frequency. The panel calibrations permit rough presetting of this control for tuning purposes.

4.9. FINAL TUNING.

This control is a variable capacitor in the final plate circuit and will resonate this circuit to the desired output frequency. The panel calibrations permit rough presetting of this control for tuning purposes.

NOTE

Both the DRIVER TUNING and FINAL TUNING are to be adjusted for maximum meter deflection at the operating frequency.

4.10. DELAY.

The DELAY control is a potentiometer which determines how long the transmitter will stay on after voice modulation or CW keying has ceased when the OPERATION switch is in the VOX position. Rotating the control clockwise will increase the "ON" time.

4.11. MIC GAIN.

This control is a potentiometer connected in the grid circuit of the second audio amplifier stage for adjusting the amount of audio drive to the modulators. This control has sufficient range to permit adjustment for any high-level crystal or low-level dynamic microphone normally used for voice communication. (See paragraph 6-6, SINGLE SIDEBAND OPERATION, for correct MIC GAIN setting.)

4.12. VFO SELECTOR.

This is a two-position rotary switch for selecting either internal or external frequency control of the HT-44. In the XMTR position, the internal VFO of the HT-44 is placed in operation to control its frequency. The operating frequency will be indicated on the HT-44 dial. In the RCVR position, the HT-44 frequency will be controlled by the SX-117 receiver and the transmitter frequency will be indicated on the receiver dial. (See TRANSCIVE OPERATION, Section VII.)

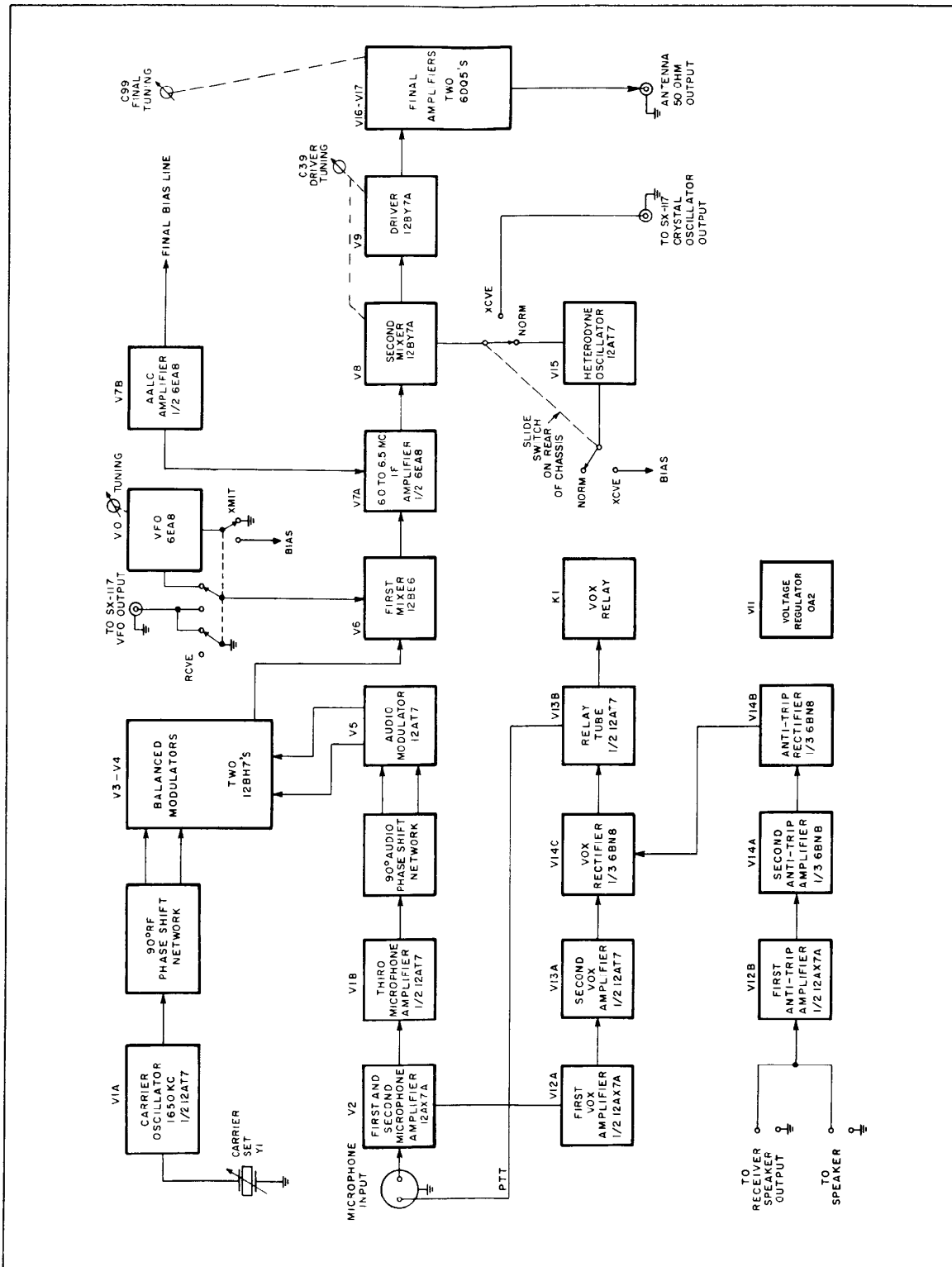

Figure 7. Block Diagram of the Model HT-44 Transmitter/Exciter.

156-002625

SECTION V

THEORY OF OPERATION

5.1. GENERAL DESCRIPTION.

The HT-44 utilizes the phasing principle of sideband generation. The circuits are designed so that the sideband signal is generated at a single carrier frequency that is ultimately converted to the desired operating frequency. With this method, carrier and sideband rejection remain constant, regardless of operating frequency, and assure maximum long-term suppression stability. The circuitry also incorporates techniques which permit generation of continuous wave (CW) and double-sideband (AM) signals.

5.2. SIDEBAND GENERATION.

The audio section of the sideband generator consists of three stages of audio amplification, followed by a low-pass audio filter, C85, C86, and L20, which attenuates frequencies above 3000 CPS. The audio voltage is fed in parallel to the combination of the Audio Phase Bal control, R65, and the audio phase-shift network. The Audio Phase Bal control is adjusted so that the outputs of the audio phase-shift network are equal and 90 degrees out of phase with respect to each other. The two voltages are then independently amplified by the dual-triode Audio Modulator, V5, and transformer coupled to the grids of the Balanced Modulators, V3 and V4. The Audio Bal control, R70, provides a means of equalizing the relative gains of the audio modulators to produce equal outputs.

Tube V1A is a 1650-KC, crystal-controlled oscillator which generates the carrier frequency. The output of this oscillator is fed to a 90-degree RF phase-shift network (R5, R6, L1, and C6) where it is split into two equal-amplitude components that are 90 degrees out of phase with respect to each other. These two voltages are fed to the input of the Balanced Modulators, V3 and V4.

Tubes V3 and V4 comprise a double-balanced modulator circuit consisting of two single-balanced modulators with separate input circuits and a common output circuit. Considering the single-balanced modulator V3, it is noted that the plates are connected in push-pull through the tank circuit, T2, C14, and C15. The grids are connected in parallel for RF through C5 and C8, and in push-pull for audio through L21 and L22. The Carrier Bal control, R8, permits equalization of gain between V3A and V3B so that, with an in-phase RF signal at the grids, the resultant output voltages are equal in amplitude and produce essentially zero output. A push-pull audio frequency applied to the grids through L21 and L22

produces sum and difference frequencies (carrier frequency \pm audio frequency) which, in the output, are 180 degrees out of phase with respect to each other. This produces a net output at the transformer link of two side frequencies, equal in amplitude, displaced by the frequency of the audio signal from the suppressed carrier.

The operation of the other balanced modulator V4, supplied with input voltages that are 90 degrees out of phase with respect to V3, is such that one of the side frequencies produced is exactly 180 degrees out of phase with the corresponding side frequency of V3, and the other is exactly in phase. Consequently, the in-phase components add, the out-of-phase components cancel, and the net result is a single-sideband suppressed-carrier signal.

Selection of the other sideband is accomplished by reversal of the audio input phase to V4 by means of the FUNCTION switch.

A double sideband (AM) signal is generated by removing the audio from V4 and introducing a fixed amount of unbalance in V3 through R10. V4, therefore, remains balanced at the carrier frequency and does not enter into the resultant. V3, however, produces sum and difference frequencies, along with the now-present carrier frequency. With no opposite-phase components present, the result is a double-sideband signal with carrier.

CW is similar to AM operation, with the exception that the audio signal to both balanced modulators is blocked by cutoff bias applied to the grid of the First Audio Amplifier V2A, resulting in the production of an unmodulated carrier frequency.

Depending on the setting of the FUNCTION and OPERATION switches, the signal is transferred from the link of T2 by either the FUNCTION switch or the OPERATION switch (USB, LSB, and CAL) or through the RF LEVEL control, R18 (CW and AM), to the grid of the First Mixer, V6.

5.3. VFO AND FIRST MIXER.

The VFO (variable frequency oscillator) is a highly-stable, temperature-compensated, series-tuned oscillator, covering the frequency range from 4350 KC to 4850 KC. Coil L2, in the oscillator plate circuit, is used for wave shaping and uniform output over the VFO tuning range.

The oscillator is then fed into a cathode follower to provide isolation and impedance transformation. Normally, the output of the cathode follower is fed through the VFO SELECTOR switch to the First Mixer, V6. The RCVR VFO line is connected to ground when the HT-44 VFO is in operation.

If the RCVR VFO is used (transceive), cutoff bias is applied to the HT-44 VFO tube, V10, and the cathode follower is disconnected from the first mixer. Simultaneously the RCVR VFO is connected to the first mixer.

The VFO frequency (4350 to 4850 KC) is added to the 1650-KC carrier frequency in the first mixer to produce an intermediate frequency of 6.0 MC to 6.5 MC.

It should be noted that with the heterodyning system used, the VFO and first IF frequencies will be highest at the low-frequency end of the dial (reversed tuning).

5.4. 6.0 TO 6.5 MC FIRST IF.

The IF system is comprised of T3, T4, and V7A. T3 and T4 are double-tuned bandpass transformers that accept signals in the 6.0 to 6.5 MC range and reject all others. Tube V7A is used to amplify signals in this range.

5.5. SECOND MIXER AND HETERODYNE CRYSTAL OSCILLATOR.

The output of T4 is fed to the grid of the Second Mixer, V8. Also, the output of the heterodyne crystal oscillator/cathode follower is fed through the rear-mounted slide switch to the grid of V8. With this switch in the NORM (UP) position, the HT-44 crystal oscillator functions in a normal manner to supply injection voltage to the second mixer. With the slide switch in the XCVE (down) position, cutoff bias is applied to the crystal oscillator, the cathode follower is disconnected from the mixer, a new set of gain equalization resistors are selected, and the external Xtal Osc jack is connected to the mixer.

If the HT-44 is used in conjunction with an SX-117 receiver, the slide switch should always be in the XCVE (transceive) position. This means that the SX-117 will supply the necessary crystal-oscillator injection voltage, and transceive (slave) or independent operation will be controlled by the VFO SELECTOR switch on the HT-44 front panel. Obviously, the SX-117 receiver must be turned on to satisfy this condition.

If the HT-44 is not used with an SX-117 receiver, the rear-mounted slide switch must be in the NORM (up) position for internal crystal-oscillator injection.

Injection to the second mixer will be 6.0 MC above the high-frequency end of each band segment; i.e., with the BAND SELECTOR set for 3.5 to 4.0 MC, add 6.0 MC to the high-frequency end (4.0). This gives an injection, or crystal frequency of 10.0 MC.

The output of the second mixer is tuned to the transmitter output frequency by one section of the DRIVER TUNING capacitor, C39A, and its associated coil which is selected by the BAND SELECTOR switch. Also, in the plate circuit of the second mixer, a 6.0 to 6.5 MC trap, L11, is used to prevent these frequencies from appearing in the transmitter output.

5.6. DRIVER STAGE.

The output of the Second Mixer, V8, is coupled to the grid of the Driver, V9, where it is amplified, at the transmitter output frequency, to provide the necessary drive voltage to the final amplifier tubes. The plate circuit of the driver stage is tuned to the transmitter output frequency by the remaining section of the DRIVER TUNING capacitor, C39B, and its associated coil.

5.7. FINAL AMPLIFIER.

The final amplifier stage consists of two 6DQ5 tubes, V16 and V17, connected in parallel, operating as class AB1 linear amplifiers. The output of these tubes is coupled into a pi network designed for 50-ohm fixed termination. The BAND SELECTOR switch selects the correct coil tap and output loading capacity for each tuning range. The final amplifier is tuned to resonance by the FINAL TUNING capacitor, C99.

Bridge neutralization is used in the final amplifier stage to assure stable operation throughout its tuning range.

IMPORTANT

The final amplifier bias must be set before any further checks are made. See paragraph 9-3.

Use only matched 6DQ5 tubes when replacing the final amplifier tubes. The tubes must be matched within 10 MA idling current. See paragraph 9-4.

NOTE

The bias adjustment control is on the rear apron of the PS-150-120 Power Supply.

5.8. VOX AND ANTI-TRIP CIRCUITS

The VOX and Anti-Trip controls are located at the top, left-front corner of the chassis as illustrated in figure 14. Both controls, as well

as the front panel DELAY control are utilized in conjunction with VOX operation, and are adjusted to provide control of the transmitter and receiver.

1. The VOX control, R80, is an audio sensitivity control which determines the audio level that will trip (energize) the VOX relay and cause the transmitter to operate. This control should be adjusted with the microphone at the normal speaking distance from the mouth. Advance the VOX control to a setting slightly beyond the point that will "trip" the relay (use normal voice). Excessive sensitivity will cause the transmitter to be turned on by random noise. Note that the VOX sensitivity and MIC GAIN controls are separate level adjustments; therefore, turning down the MIC GAIN control will not reduce the VOX sensitivity.

2. The Anti-Trip control, R103, is also used in conjunction with VOX operation to adjust the amount of anti-trip (bucking) voltage fed from the receiver into the VOX diode. It should be noted that excessive anti-trip voltage is capable of completely blocking normal VOX operation. Therefore, minimum anti-trip gain should be used. Adjustment should be made with the receiver running at normal output volume.

3. The DELAY control, R90, should be adjusted in conjunction with the VOX and Anti-Trip controls to control the transmitter "ON" time after modulation has ceased.

It should be noted that all of these controls have some interaction and the adjustments should be repeated until the desired results have been obtained.

The functions of VOX and Anti-Trip are accomplished by sampling the audio signal at the First Audio Amplifier grid, V2. This signal is amplified by V12A and V13A and rectified by

diode, V14C, causing the Relay Tube, V13B, to energize the VOX relay; thus placing the transmitter in operation. The anti-trip circuit, supplied with a sample of the receiver's audio output, rectifies this voltage which appears as a "bucking" voltage at the VOX diode. Delay is accomplished by charging capacitor C112 which causes the relay tube to continue to conduct until C112 has discharged. The rate of discharge is controlled by the setting of the DELAY control.

5-9. AALC (AUTOMATIC AUDIO LEVEL CONTROL).

When a small amount of grid current occurs in the final amplifier, an audio signal appears on the amplifier bias line, in proportion to the amount of grid current. This audio signal, which is not present without final amplifier grid current, is coupled to the AALC Amplifier, V7B, whose output is rectified by diodes CR1 and CR2. The resulting DC voltage, after filtering, is applied to the grid of the 6.0 to 6.5 MC Amplifier, V7A, as gain-control bias.

5-10. METER CIRCUIT.

This circuit consists of a voltage-divider network, a diode rectifier with filter, and a meter for visual indication of the relative RF output voltage appearing across the 50-ohm output. This is not a peak reading voltmeter; therefore, the meter reading on voice peaks will be approximately one third of its equivalent CW indication. Any load termination other than 50 ohms resistive will cause the meter to read higher or lower depending on the sign of the reactance present at the HT-44 output. This will be noted as an apparent change of maximum output when tuned across a band as the VSWR of most antenna systems is not constant with frequency. This will be especially noted on the lower frequency bands where the change over the band is greater.

SECTION VI TUNING PROCEDURE

6-1. GENERAL.

The tuning procedure for the HT-44 is not complicated; however, care should be exercised in tuning to insure peak performance. Tuning (peaking) should be performed on or near the intended operating frequency on all bands.

If the VFO is tuned any appreciable amount away from the frequency at which the transmitter has been previously tuned, it will be necessary to repeak the DRIVER and FINAL TUNING controls for maximum output.

As experience is gained in operating over the various bands, the operator will be able to judge when he has tuned far enough to require re-peaking. In general, very little re-peaking will be required for operation on the 10, 15, and 20 meter bands with somewhat more frequent re-tuning being needed on the 40 and 80 meter bands when changing frequency.

The output of the transmitter should always be connected to a 50 ohm, resistive dummy load or a suitable antenna that is near 50 ohms for the operating frequency.

IMPORTANT

The bias must be adjusted before proceeding to the following steps. It has not been pre-adjusted at the factory. Failure to do so will result in improper operation and possible permanent damage to the final tubes. See paragraph 9-3.

6.2. BASIC TUNING.

Preset the indicated controls as follows:

OPERATIONMOX
FUNCTIONCW
RF LEVEL0
DRIVER TUNING . . .Desired band segment
FINAL TUNING . . .Desired band segment
BAND SELECTOR . . .Desired band
TUNINGDesired frequency
MIC GAIN0

1. Adjust the RF LEVEL control until a small indication is observed on the meter.
2. Adjust the FINAL TUNING control for maximum meter reading.
3. Reduce the RF LEVEL control setting as necessary to keep meter below the one-half scale reading.
4. Adjust the DRIVER TUNING control for maximum meter reading.

NOTE

Meter reading should not be allowed to exceed one-half scale during tuning.

6.3. MANUAL CW OPERATION.

Use the procedure as outlined in paragraphs 6-1 and 6-2. If a key is plugged into the key jack, it must be closed.

Advance the RF LEVEL control to a point just below saturation. Saturation is determined by slowly advancing the RF LEVEL control to the point where further advancement does not appreciably increase the output meter reading. The RF LEVEL control should be set slightly below this point.

The transmitter is now ready to key. To receive, it will be necessary to turn the OPERATION switch to STBY.

6.4. BREAK IN CW OPERATION.

Use the tuning procedure described for manual CW operation and set the OPERATION switch at VOX.

Adjust the DELAY control for the desired drop-out time. Rotating the DELAY control clockwise will increase the drop-out (delay) time. The transmitter is now ready for break-in CW operation.

6.5. AM (DSB) OPERATION.

Use the tuning procedure as described for manual CW operation.

1. Set the FUNCTION switch to AM.
2. Advance the RF LEVEL control to the point of saturation as described in paragraph 6-3 and note the RF output meter reading.
3. Reduce the RF LEVEL control setting until the meter indicates exactly one-half of its original reading. This will be the maximum carrier that can be 100% modulated.
4. Slowly increase the MIC GAIN control setting until a very slight meter indication is observed on loud voice peaks.
5. Because of the larger duty cycle experienced in AM operation (constant carrier with high plate dissipation), either voice-control or push-to-talk operation should be used to reduce the duty cycle to a minimum. This will reduce the amount of heat developed and add to the life of the final amplifier tubes.

6.6. SINGLE-SIDEBAND OPERATION (SSB).

1. Use the basic tuning procedure described in paragraph 6-2.
2. Set the FUNCTION switch to USB or LSB as desired. Note that the RF LEVEL control is disabled in SSB and will have no effect on the output.
3. Advance the MIC GAIN control clockwise. The normal setting will usually be between 3 and 5; however, this will be influenced by the type of microphone used, individual voice characteristics, etc. If possible, a monitor oscilloscope should be used to determine the optimum control setting. If this is not possible, several air checks should be made with other stations using various MIC GAIN control settings.

IMPORTANT

Do not depend on the AALC circuitry to correct for improper MIC GAIN control settings. Even though this circuitry is very effective, it is still possible to drive a low-level stage into distortion. Never advance the MIC GAIN control further than necessary to maintain communication.

SECTION VII

TRANSCEIVE (SLAVE) OPERATION

IMPORTANT

Do not attempt to change the type or length of the coaxial cables used in the CA-44 cable assembly. These cables must be Type RG-62/AU coaxial, 28 inches long, 93 ohms impedance. See figure 8.

7.1. INTERCONNECTION OF UNITS.

The SX-117 and the HT-44 must be connected together through an optional CA-44 cable assembly, or its equivalent, for slave operation.

Two special coaxial cables are provided to connect the SX-117 XTAL OSC output, and the SX-117 VFO output to the HT-44. Also, an eleven-pin plug with three wires and lugs is provided for connecting the SX-117 speaker and muting terminals into the HT-44.

1. Insert the eleven pin plug into the HT-44.
2. Connect the green wire to the SX-117 3.2-ohm speaker terminal.
3. Connect the yellow wire to the SX-117 REC/STBY terminal (remove jumper).
4. Connect the black wire to the adjacent GND terminal on the SX-117.
5. Connect one coaxial cable from the SX-117 XTAL OSC jack to the HT-44 XTAL OSC jack.

6. Connect the remaining coaxial cable from the SX-117 VFO jack to the HT-44 VFO jack.

All terminals and jacks are located on the rear chassis aprons of the two units.

7. Place the slide switch on rear of the HT-44 in the XCVE (down) position.

NOTE

These connections are in addition to the usual antenna and changeover relay connections which are normally made.

8. Place the SX-117 FUNCTION switch in USB and the HT-44 OPERATION switch in STBY and allow at least 15 minutes warmup time.

9. Very carefully adjust the SX-117 BFO control so that zero beat is maintained when switching from USB to LSB as described in the SX-117 manual.

NOTE

The BFO control must remain at this point at all times if "on-frequency" transceive operation is to be achieved.

10. Place the HT-44 VFO SELECTOR switch to RCVR.

11. Place the HT-44 OPERATION switch to CAL.

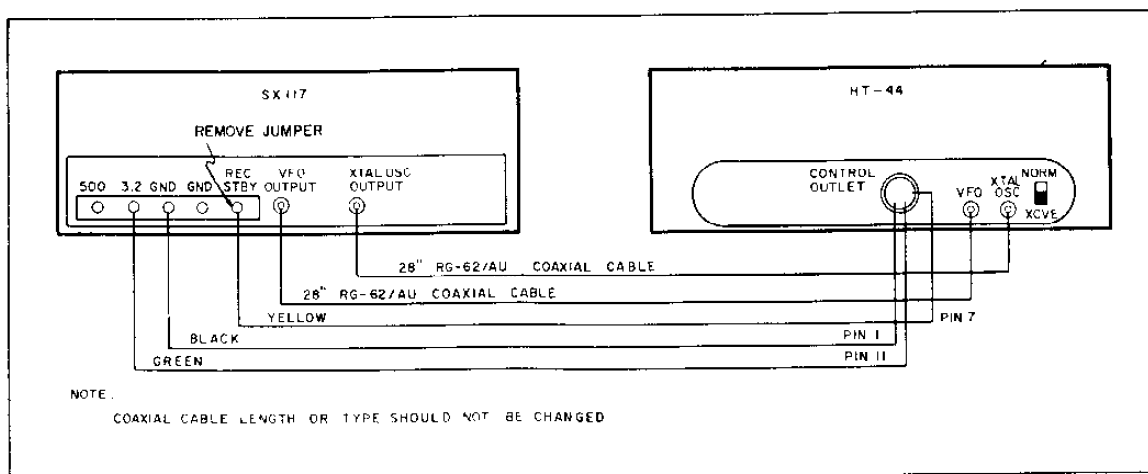

Figure 8. Transceive Connections Between HT-44 and SX-117, Using CA-44 Cable Assembly.

156-002569

12. Rotate the HT-44 CAL LEVEL control clockwise for a strong beat note response in the SX-117.

NOTE

RF GAIN and AUDIO GAIN controls in the SX-117 should be well advanced. Also, the SX-117 NOTCH control should be rotated fully counterclockwise (above 54 KC) for this check.

13. Carefully adjust warping trimmer C1 in the HT-44 for zero beat. This trimmer is located near the top, left, rear corner of the chassis. (See figure 14.)

NOTE

In certain early production SX-117 receivers having 1600 and 1700 KC crystals bearing part number 019-201902, it may not be possible to quite reach zero beat as described in step 13.

If it has been ascertained that this condition exists, contact Hallicrafters' Service Department, 4401 West Fifth Avenue, Chicago 24, Illinois, for further instructions giving serial number and date of purchase.

14. With the HT-44 VFO SELECTOR switch in the RCVR position, the operating frequency of the HT-44 and SX-117 will be the same and will be that frequency indicated on the SX-117 dial. If the receiver is tuned any appreciable amount away from the frequency at which the transmitter has been previously tuned it will be necessary to repeak the DRIVER and FINAL TUNING of the HT-44 for maximum output. As experience is gained in operating over the various bands the operator will be able to judge when he has tuned away from the tune-up frequency far enough to require repeaking. In general, very little repeaking will be required for operation on the 10, 15, and 20 meter bands with somewhat more frequent repeaking being needed on the 40 and 80 meter bands when changing frequency.

With the HT-44 VFO SELECTOR switch in the XMTR position, the TRANSMIT frequency will be that which is indicated on the dial of the HT-44. In either case, the SX-117 must be turned on to supply crystal oscillator injection voltage to the HT-44.

CAUTION

In slave operation, care must be exercised to avoid illegal operation. It must be remembered that you will transmit wherever the receiver is tuned.

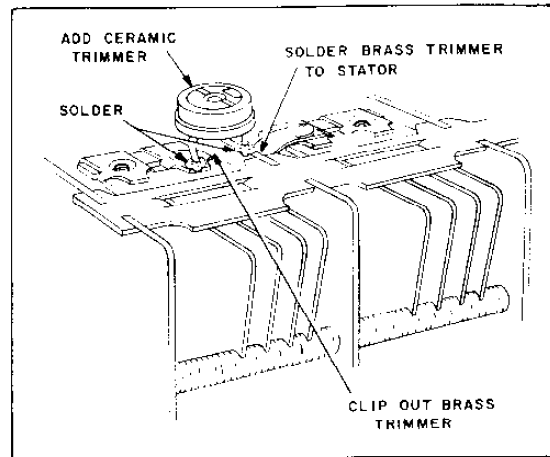

Figure 9. SX-117 Trimmer Modification.

7.2. SX-117 NOTES.

Certain modifications have been made to the SX-117 receiver to improve its performance. Item 1 should be performed, if not already incorporated in your set. Item 2 is optional.

1. In sets below serial number 117001, R15, a 470-ohm cathode resistor for V5, was connected to ground. In later sets it was removed from ground and connected into the muting line to improve receiver cutoff during transmission.

2. In sets below serial number 117004, a brass compression trimmer was used as the VFO trimmer (C15F) on the top of the front section of a three-section gang. If VFO drift or long-term calibration accuracy has been a problem, this should be changed to a silver ceramic type.

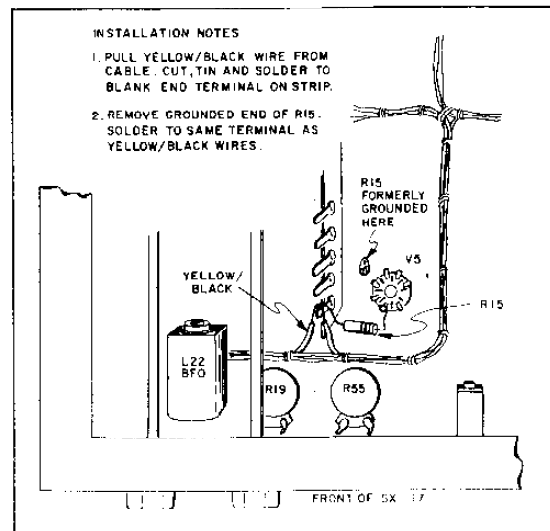

Figure 10. SX-117, V5 Cathode Resistor Modification.

See figures 9 and 10 for complete details on these changes. Contact the Hallicrafters' Service Department, 4401 West Fifth Avenue, Chicago 24, Illinois, for the replacement VFO trimmer. No other parts are required.

itemized in paragraph 7-1. Figure 11 details the plug and wire makeup for the speaker and muting connections.

7.3. CA-44 CABLES.

The model CA-44 consists of a set of cables made up specifically for interconnecting the SX-117 and HT-44 for transceive (slave) operation. The makeup and connection of these cables are

PARTS LIST CA-44 CABLE ASSEMBLY

QTY	DESCRIPTION	HALLICRAFTERS PART NUMBER
2	Coaxial Cable (Patch)	087-007936
1	Control Cable Assembly (See Figure 11)	087-008005

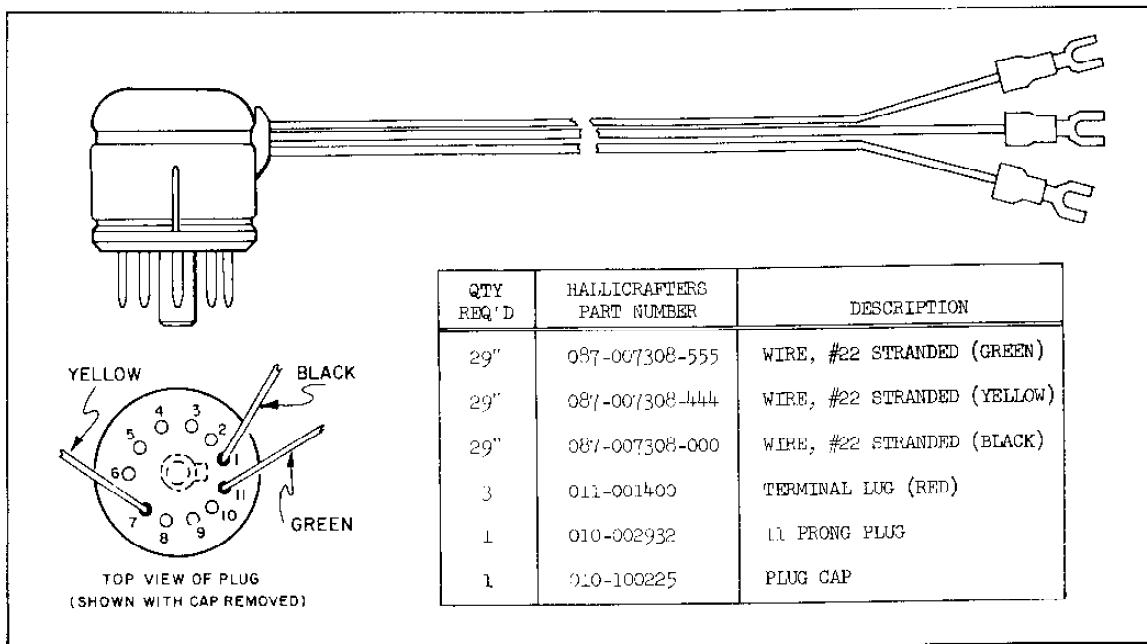

Figure 11. Model CA-44 Control Cable Showing Fabrication.

156-002714

SECTION VIII SERVICE DATA

8.1. COVER AND CHASSIS REMOVAL.

A. TOP COVER REMOVAL. - Loosen the four top-cover screws 1/4 turn only and remove cover. To replace cover, tighten cover screws 1/4 turn only, so that the plastic latch nuts will not be damaged.

B. BOTTOM COVER REMOVAL. - Remove the four bottom cover screws located in the feet, and remove the cover. When replacing the bottom cover, make certain that the grounding clip on the cover engages properly at the final amplifier shield partition.

C. CHASSIS REMOVAL. - To remove the chassis from the cabinet, it is first necessary to remove the bottom cover (see paragraph 8-1B).

Remove the four cabinet screws at the bottom near the cabinet feet and carefully slide the chassis and panel assembly out from the front of the cabinet.

8.2. TUBE AND DIAL LIGHT REPLACEMENT.

Access to the dial light and all tubes may be obtained by removing the top cover of the cabinet. See paragraph 8-1A.

8.3. TROUBLESHOOTING.

In the design of this transmitter, full consideration was given to keep maintenance problems at an absolute minimum. As in all well-designed electronic equipment, maintenance and repair problems are generally confined to the

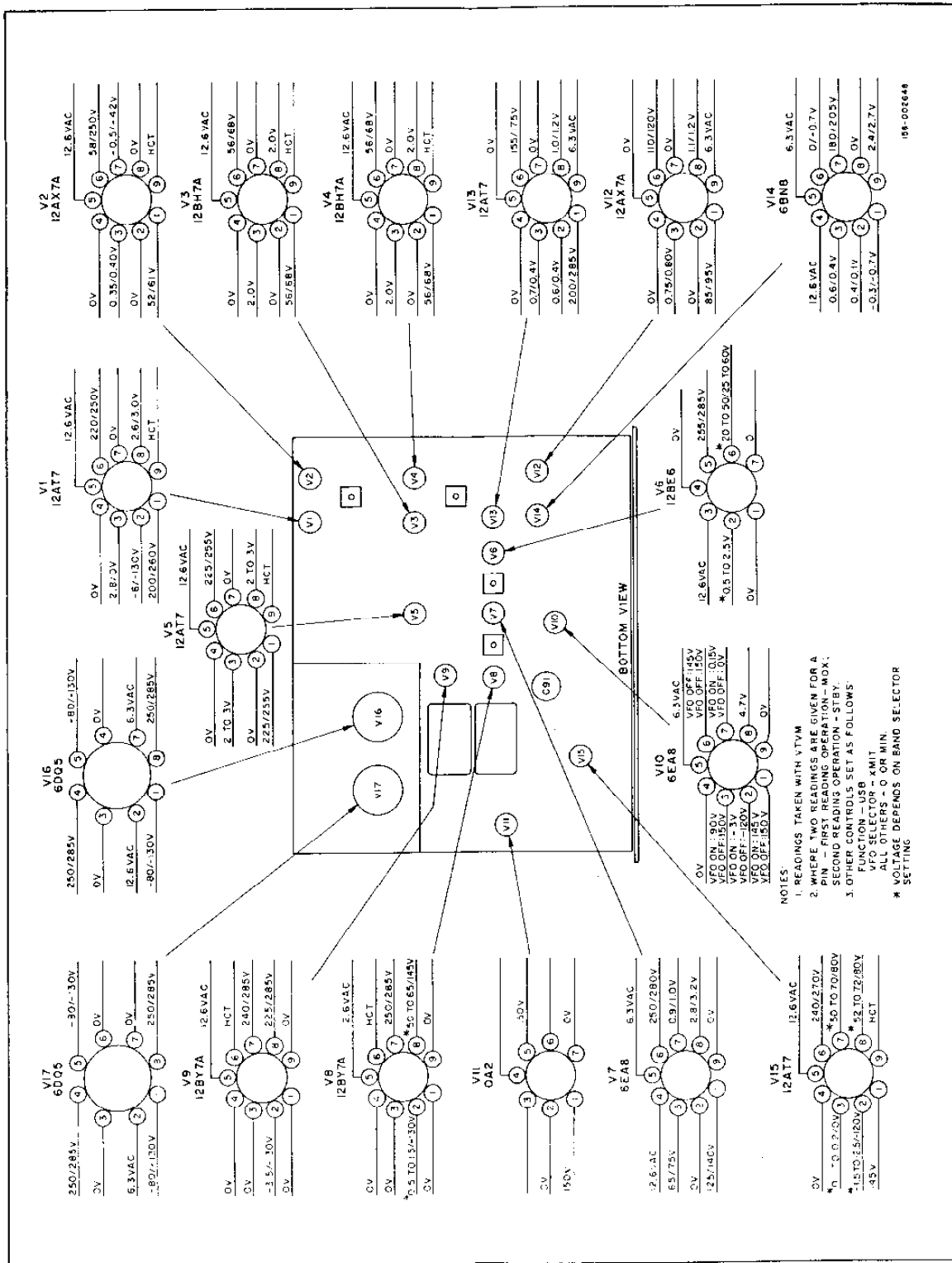

Figure 12. Voltage Chart.

156-002648

checking and replacement of tubes and semi-conductor devices which may become defective. Malfunctions of this nature are usually easily isolated and corrected. However, it is entirely possible that a more obscure malfunction may arise. In this event, only thoroughly trained technical personnel should attempt to service equipment of this complexity.

A recommended aid to troubleshooting the Model HT-44 transmitter is a general-coverage receiver which can be used to provide a quick check on the various oscillator circuits within the HT-44. A lead connected to the antenna of this receiver, when placed in the proximity of the oscillator tube in the circuit to be checked, can determine the presence or absence of signal from the stage in question.

If a malfunction occurs when operating on one particular band and/or mode of operation, the unit should be checked on all other bands and in all other modes of operation to isolate the difficulty. A careful study of the block diagram (figure 7) will give a quick clue as to which tubes should be checked. The voltage and resistance charts (figures 12 and 13) and schematic diagram (figure 22) will also aid in isolating and correcting a malfunction.

8-4. SERVICE AND OPERATING QUESTIONS.

For further information regarding operation or servicing of the Model HT-44 Transmitter, contact the dealer from whom the unit was purchased. The Hallicrafters Company maintains an extensive system of Authorized Service Centers

where any required service will be performed promptly and efficiently at no charge if this equipment is delivered to the service center within 90 days from date of purchase by the original buyer and the defect falls within the terms of the warranty. It is necessary to present the Bill-of-Sale in order to establish warranty status. After the expiration of the warranty, repairs will be made for a nominal charge. All Hallicrafters Authorized Service Centers display the sign shown below. For the location of the one nearest you, consult your dealer or your local telephone directory.

Make no service shipments to the factory unless instructed to do so by letter, as The Hallicrafters Company will not accept responsibility for unauthorized shipments.

The Hallicrafters Company reserves the privilege of making revisions in current production of equipment and assumes no obligation to incorporate such revisions in earlier models.



SECTION IX ALIGNMENT PROCEDURE

WARNING

LETHAL HIGH VOLTAGE IS PRESENT WITHIN THIS EQUIPMENT. BE CAREFUL WHEN INSTALLING THE UNIT, WHEN MAKING BIAS ADJUSTMENTS, AND WHEN PERFORMING CHECKS UNDER THE CHASSIS.

9.1. GENERAL.

The Model HT-44 Transmitter has been accurately aligned and calibrated at the factory and, with normal usage, will not require realignment for extended periods of time. Service or replacement of a major component or circuit may require subsequent realignment, but under no circumstances should realignment be attempted unless the malfunction has been analyzed and definitely traced to mis-alignment. Alignment should only be performed by persons experienced in this work, using the proper test equipment.

NOTE

Do not make any adjustments unless the operation of this transmitter is fully understood and adequate test equipment is available. Refer to figures 14 and 15, the top and bottom views of the transmitter, for the locations of all adjustments.

9.2. EQUIPMENT REQUIRED.

1. RF Signal Generator; Measurements Corporation, Model 65B or an equivalent signal generator having up to one volt output at an impedance of 70 ohms or less (a 100 micro-microfarad DC blocking capacitor must be placed in series with the RF lead).

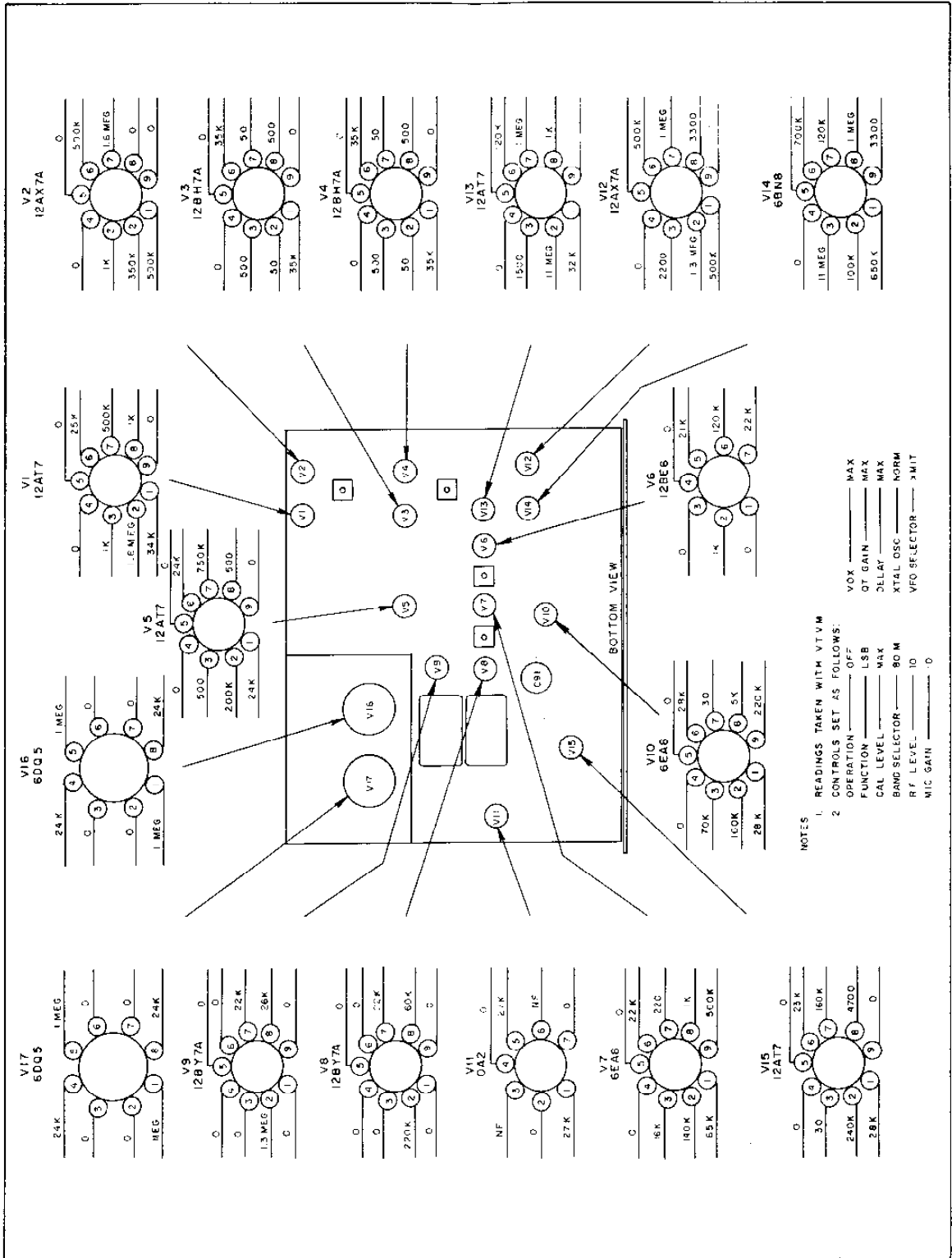

Figure 13. Resistance Chart.

2. A Vacuum Tube Voltmeter (VTVM); Hewlett-Packard Model 410B, or equivalent VTVM having an RF probe good to 30 MC.

3. A Dummy Load; 50 ohms non-reactive, rated at 150 watts. Bird Wattmeter or equivalent. The load may be made up of carbon resistors totaling 150 watts dissipation.

4. A DC Voltmeter having a 2.5-volt or 3.0-volt scale for final plate current measurements, when using the Model PS-150-120 Power Supply, or a 0 to 500 MA DC milliammeter.

5. A sine-wave audio oscillator.

6. A general-coverage receiver covering the frequency range from 3 MC to 30 MC with a 100-KC calibrator.

9.3. BIAS ADJUSTMENT.

It is imperative that a bias adjustment be made before operating or checking the HT-44. The bias has not been pre-set at the factory; therefore, improper operation or possible permanent damage to the final tubes may occur if this adjustment is not made.

The bias adjustment control is located on the rear chassis apron of the PS-150-120 Power Supply.

CAUTION

High voltage will be present at the two tip jacks used as test points. Be sure that the HT-44 OPERATION switch is in the OFF position.

1. Remove back cover from the PS-150-120 Power Supply and connect a volt meter or a DC milliammeter capable of reading 100 MA (positive lead to the red jack and negative lead to the blue jack). Set the voltmeter on the 2.5 or 3.0 volt range. There is a 10-ohm resistor across the tip jacks so that the meter will indicate 1 volt for 100 MA.

2. Set the OPERATION switch at STBY and allow at least five minutes for warmup.

3. Set the RF LEVEL control at 0 (no transmitter output).

4. Set the OPERATION switch at MOX.

5. Set the FUNCTION switch at CW.

6. Adjust the BIAS ADJ. control on the power supply for a one volt (100 MA) reading on voltmeter. This is the idling current for the final tubes.

7. Return the OPERATION switch to OFF.

8. Remove the meter leads and replace the rear cover on the power supply.

NOTE

The idling current should be checked periodically and should be maintained between 90 and 100 MA. If the final tubes are replaced, the bias must be re-adjusted for these tubes. (See FINAL TUBE MATCHING, paragraph 9-4.)

9.4. FINAL (6DQ5) TUBE MATCHING.

If either or both 6DQ5 tubes are replaced, tube matching will be required. This may require access to a number of tubes in order to select those with the desired characteristics. Matched pairs of tubes are available through Hallicrafters' Service Department for customer convenience.

The procedure for tube matching the HT-44 is as follows:

CAUTION

It will be necessary to come into contact with circuits which normally have high voltage applied to them. Use extreme care while performing the following operations. Use a well-insulated screwdriver or other suitable tool to short the 6DQ5 plate caps to the chassis before making body contact with them.

1. Set the OPERATION switch at OFF.

2. Turn the four top cover retaining screws one-quarter turn counterclockwise and lift off the top cover.

3. Remove the top cover from the final amplifier cage.

4. Remove bottom cover of cabinet.

5. At the socket of V16, unsolder the orange lead from pin 4 (screen). Make certain this lead does not short to the chassis when the unit is turned back on to balance the tubes.

6. Connect a voltmeter or milliammeter to the power supply tip jacks as described in BIAS ADJUSTMENT, paragraph 9-3.

7. Set the OPERATION switch at STBY and allow approximately two minutes warmup.

8. Set the RF LEVEL control at 0.

9. Set the OPERATION switch at MOX.

10. Set the FUNCTION switch at CW.

11. Adjust the BIAS ADJ control for a 0.5-volt (50 MA) reading on the voltmeter.

12. Return the OPERATION switch to OFF.

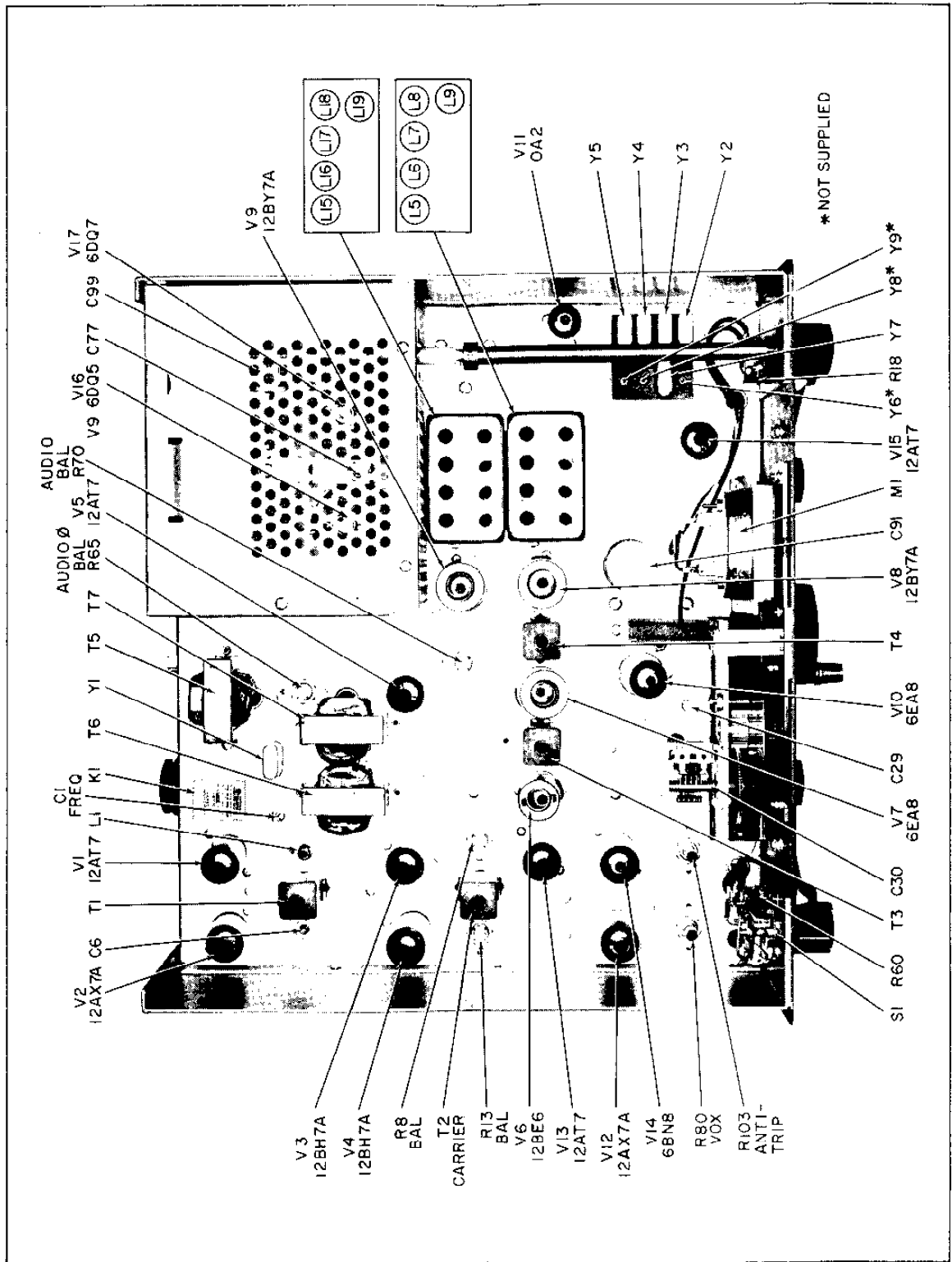

Figure 14. Top Chassis View Showing Component Locations.

156-002698

13. Short the 6DQ5 plate cap to the chassis and remove the tube from its socket.

14. Insert a new 6DQ5 tube into the socket of V17 (the socket nearest the outside edge of the chassis).

15. Place the OPERATION switch in STBY and allow approximately two minutes for warmup.

16. Place the OPERATION switch in MOX and observe the voltmeter reading. (Do not change the bias setting.)

17. If this tube causes the voltmeter to read between 0.4 volt (40 MA) and 0.6 volt (60 MA), it can be considered as being matched to the original tube. If the difference in reading exceeds 0.1 volt (10 MA), other tubes must be checked until the difference reading of the pair to be matched is less than 0.1 volt (10 MA).

18. Reconnect the orange lead to pin 4 of V16.

NOTE

If both tubes are defective, both tubes should be removed. Then a new tube should be installed in each socket.

9-5. RF ALIGNMENT, DRIVER PLATE (V9), AND MIXER PLATE (V8) CIRCUITS.

NOTE

The RF output of the transmitter (at J7) must be terminated with a 50-ohm 150-watt, resistive dummy load when RF ALIGNMENT is being performed.

1. When only small amounts (touch up) of alignment are required, proceed as follows: refer to paragraph 6-2 for control settings; refer to the RF alignment chart (table 1) and adjust the required coil cores for maximum RF output.

TABLE 1. RF ALIGNMENT CHART

Band	Final and Driver Tuning Segment Adjust For Maximum Output	Adjust Coil Core For Maximum Output	
		Mixer Plate	Driver Plate
29.5	10		
29.0	10		
28.5	10	L5	L15
28.0	10		
21.0	15	L6	L16
14.0	20	L7	L17
7.0	40	L8	L18
3.5	80	L9	L19

2. When complete RF alignment is required, proceed as follows: connect a 50-ohm dummy load to the RF output jack (J7). Connect an RF Signal Generator to the grid of the second mixer (pin 2 of V8).

3. **10-Meter Alignment.** - Tune the Signal Generator to 28.0 MC. Set the FINAL TUNING control to the low end of the 10-meter segment (approximately 8 on the inner scale) and the DRIVER TUNING control also to the low end of the 10-meter segment (approximately 8 on the inner scale). Increase the signal generator output level until a small indication is noted on the HT-44 RF output meter. Tune the FINAL TUNING control for maximum output indication. Adjust the cores of coils L5 and L15 (see figure 14 for location) for maximum output, reducing the signal generator output level as required to keep the meter reading at half-scale or less. Set the signal generator to 29.7 MC. Set the FINAL TUNING control to the high end of the 10-meter segment (approximately 9-1/2 on the inner scale) and set the DRIVER TUNING control to the high end of the 10-meter segment (approximately 9-1/2 on the inner scale). Adjust trimmer capacitor (C39C) located on the side of C39A (see figure 15) for maximum output while slightly rocking the DRIVER TUNING control. Return the signal generator to 28.0 MC and repeat the above alignment until tracking is accomplished. (NOTE: Trimmer C39C should not be readjusted on the other bands.)

4. **15-Meter Alignment.** - Tune the signal generator to 21.0 MC and set the FINAL TUNING control to the low end of the 15-meter segment (approximately 7-1/2 on inner scale). Set the DRIVER TUNING to the low end of the 15-meter segment (approximately 7 on the inner scale). Increase the signal generator output level until a small indication is noted on the RF output meter and adjust the FINAL TUNING control for maximum output, reducing the signal generator output level as required to keep the meter at half-scale or less. Adjust the cores of coils L6 and L16 (see figure 14 for location) for maximum output, reducing the signal generator output as required to keep the meter at half-scale or less.

5. **20-Meter Alignment.** - Tune the signal generator to 14.25 MC, set the FINAL TUNING control to the center of the 20-meter segment (approximately 6-1/2 on the inner scale), and set the DRIVER TUNING control to the center of the 20-meter segment (approximately 6-1/4 on the inner scale). Increase the signal generator output level until a small indication is noted on the RF output meter and adjust the FINAL TUNING control for maximum output. Adjust the cores of coils L7 and L17 for maximum output, reducing the signal generator as required.

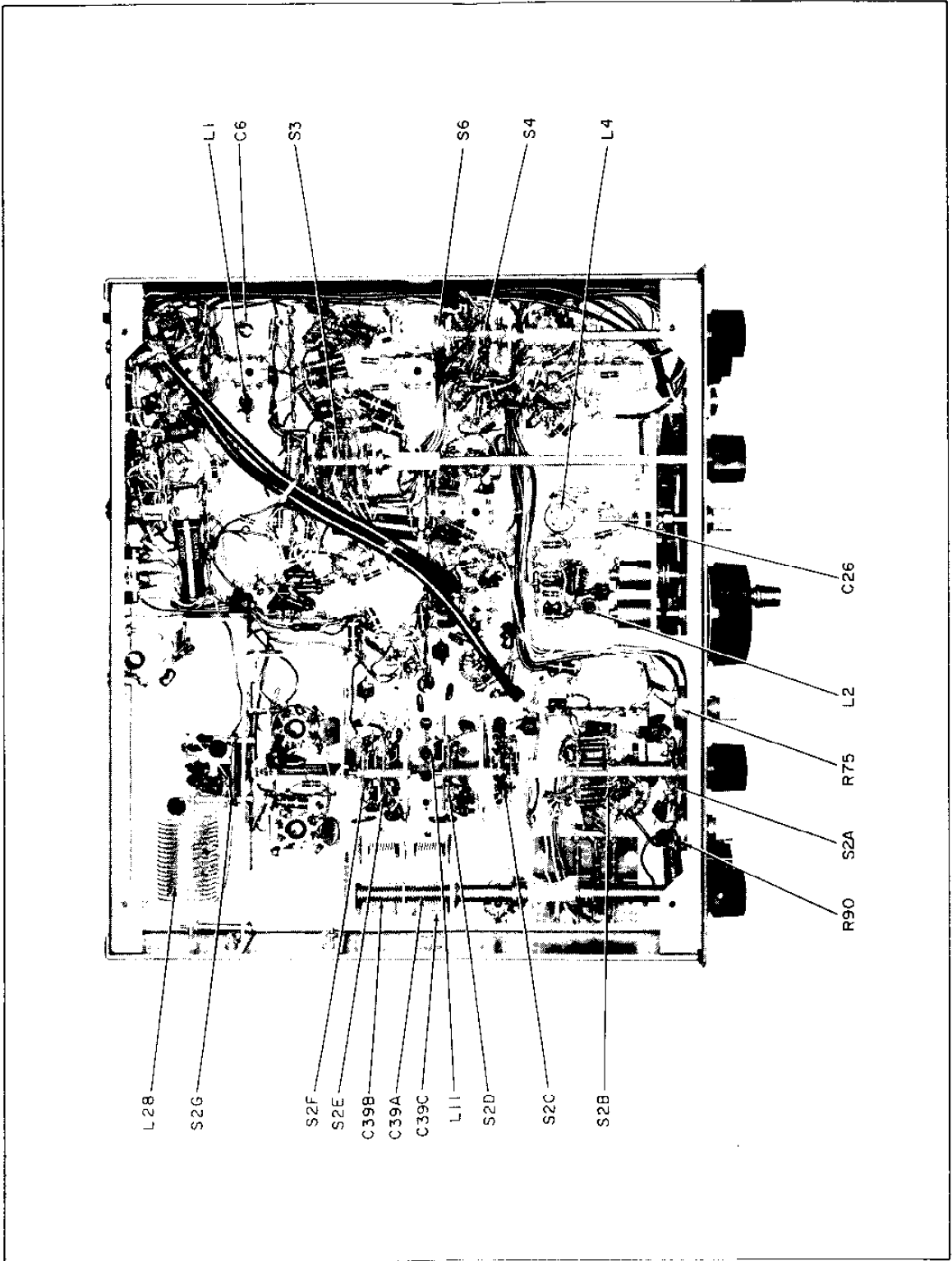

Figure 15. Bottom Chassis View, Showing Components

156-0077.12

6. 40-Meter Alignment. - Tune the signal generator to 7.15 MC, set the FINAL TUNING control to the center of the 40-meter segment (approximately 4 on the inner scale), and set the DRIVER TUNING to the center of the 40-meter segment (approximately 5 on the inner scale). Increase the signal generator output level until a small indication is noted on the RF output meter and adjust the FINAL TUNING control for maximum output. Adjust the cores of coils L8 and L18 for maximum output, reducing the signal generator output level as required.

7. 6.5-MC Trap Adjustment. - While on the 40-meter band, set the signal generator to 7.0 MC and adjust the FINAL TUNING and DRIVER TUNING controls for maximum output. Without changing the FINAL TUNING or DRIVER TUNING, reset the signal generator to 6.5 MC and increase the signal generator output level until a small indication is noted on the RF output meter. Adjust the 6.5-MC trap core, L11 (see figure 15 for location) for minimum output, increasing the signal generator output as required. A slight readjustment of L8 may be required after this adjustment.

8. 80-meter Alignment. - Set the signal generator to 3.75 MC, set the FINAL TUNING control to the center of the 80-meter segment (approximately 1-1/2 on the inner scale), and the DRIVER TUNING control to the center of the 80-meter segment (approximately 2-1/2 on the inner scale). Increase the signal generator until a small indication is noted on the RF output meter and adjust the FINAL TUNING control for maximum output. Adjust the cores of coils L9 and L19 for maximum output, reducing the signal generator output level as required.

9.6. VFO CALIBRATION.

The VFO unit has been carefully aligned and temperature compensated at the factory. Before touching-up trimmer C29 or coil L4, check the dial calibration at the 100-KC points. This may be accomplished on the 80-meter band, in CAL. function, using a receiver with a 100-KC crystal marker. If all points fall to one side of the pointer, reset the CAL. ADJ. trimmer. If the CAL. ADJ. trimmer runs out of range before calibration is accomplished it will require adjustment of trimmer C29.

Proceed as follows: Set the CAL. ADJ. trimmer to mid-range (dot up). Set the OPERATION switch to CAL. Set the BAND SELECTOR to 3.5 MC (80-meter). Tune the receiver to 3.5 MC on the 100-KC marker signal (BFO off). Set the HT-44 TUNING CONTROL (dial) to the red 500 (3.5 MC). Carefully adjust trimmer C29 for zero beat (see figure 14 for location).

Check across the dial at the 100-KC points. If the frequency error is less than 3000 CPS, the calibration is within acceptable limits. If the error at the high frequency end of the dial, 4.0 MC (red 1000), is greater than 3000 CPS, the VFO may require a coil adjustment in addition to the trimmer adjustment.

If the dial error progressively increases in the same direction with the high-frequency end running out more than 3000 CPS, at this end, both L4 and C29 should be adjusted. Proceed as follows: Set the TUNING dial to 4.0 MC (red 1000) and the Receiver to 4.0 MC. Adjust the slug of L4 (see figure 15 for location) to zero beat. Set the TUNING dial to 3.5 MC (red 500), the receiver to 3.5 MC, and adjust C29 for zero beat. Repeat the adjustments at 4.0 MC and 3.5 MC until both points are on frequency.

Check across the dial at the 100-KC points. If the frequency error is less than 3000 CPS, the calibration is within acceptable limits. If the error is more than 3000 CPS at any of the mid 100-KC points, with the end points on frequency, the VFO TUNING capacitor should be knifed. This operation should not be attempted by other than qualified personnel thoroughly familiar with this technique.

9.7. 6.0 TO 6.5 MC BANDPASS IF ALIGNMENT.

Remove V15 (12AT7) from its socket to disable the heterodyne oscillator signal. Connect the probe of the RF voltmeter to the grid of the Second Mixer (pin 2 of V8). Set the FUNCTION switch to CW and the OPERATION switch to MOX. Set the BAND SELECTOR to any 10-meter segment. Set the TUNING control dial to 250 and advance the RF LEVEL control until a small indication is noted on the RF voltmeter. Adjust the core of the VFO output coil (L2, See figure 15) for maximum reading. Set the TUNING control to 450 on the dial. Advance the RF LEVEL control until approximately 0.5 volt RMS is indicated on the RF voltmeter (HP 410 B or equal). Adjust top and bottom cores of IF transformers T3 and T4 for maximum voltmeter indication, keeping the level below 1 volt to prevent overload and false settings. After the transformers have been adjusted as described, increase the RF LEVEL control until 1 volt is indicated on the voltmeter. Tune the VFO (TUNING) across its range (0 to 500) while watching the voltmeter. The voltmeter should read between 0.8 and 1.0 volt over the entire range of the dial (0 to 500). After completion of this alignment, be certain to replace V15 (12AT7) in its socket.

9.8. NEUTRALIZATION OF FINAL AMPLIFIER.

The final amplifier may be neutralized as follows: tune the transmitter on 21.3 MC (15-meter band) in CW function into a 50-ohm resistive dummy load. This should be accomplished with a meter in the high voltage line to read final plate current. (See paragraph 9-3 for meter insertion.)

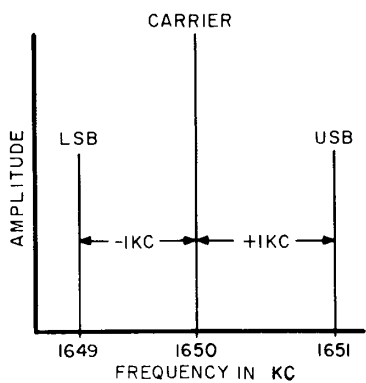

A
PANORAMIC DISPLAY OF AN AM TYPE SIGNAL. (1650KC RF CARRIER MODULATED BY A 1000 CPS AUDIO TONE).

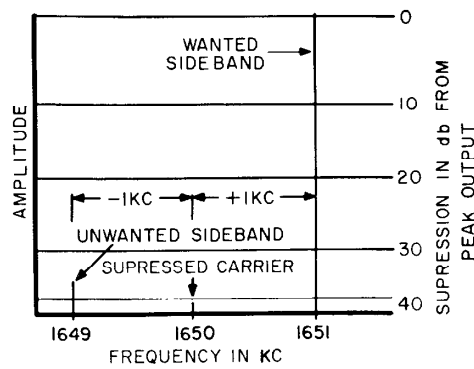

B
PANORAMIC DISPLAY OF A SSB SIGNAL WHICH WILL PRODUCE A 1000 CPS AUDIO TONE WHEN DETECTED BY A SSB RECEIVER.

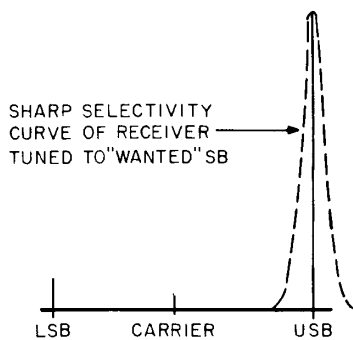

C
SHARP SELECTIVITY CURVE OF RECEIVER TUNED TO "WANTED" SB

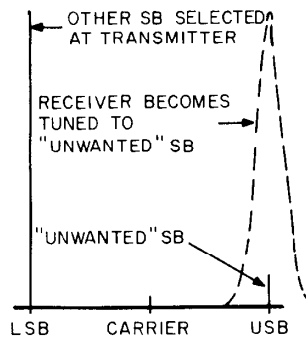

D
RECEIVER BECOMES TUNED TO "UNWANTED" SB

PANORAMIC DISPLAY OF TECHNIQUE INCORPORATED IN CHECKING AND ADJUSTING "UNWANTED" SIDEBAND REJECTION, PARAGRAPH 9-II.

Figure 16. Panoramic Sideband Displays.

156 002656

Adjust the RF LEVEL control for about 60 volts RMS output (60 on the HT-44 RF output meter). Carefully tune the FINAL TUNING control and observe the plate current dip and the output voltage peak. If both occur at the same setting, the amplifier is neutralized. If both do not occur together, adjust the neutralizing capacitor, C77 (see figure 14), in small increments (1/4 to 1/2 turn) until neutralization is accomplished.

9.9. CARRIER FREQUENCY ADJUSTMENT.

When the HT-44 is used as an independent transmitter/exciter, there is normally no need for adjustment of the carrier frequency trimmer C1 (see figure 14 for location). However, when the HT-44 is to be used in conjunction with an SX-117 receiver as a transceiver, the carrier frequency trimmer C1 must be set correctly. For this procedure, see Section VII, TRANSCIVE (SLAVE) OPERATION.

9.10. BALANCED MODULATOR OUTPUT TRANSFORMER ADJUSTMENT.

With the transmitter tuned to 14.25 MC (20-meter band) into a 50-ohm resistive dummy load, this transformer is adjusted to set the overall gain of the transmitter. Proceed as follows:

Connect an audio signal generator to the MIC connector (pin 1); ground pin 2 of the MIC connector, set the OPERATION switch to USB or LSB and the MIC GAIN control at maximum (10). Set the audio signal generator to 1000 CPS and adjust the generator output level to approximately 3 millivolts RMS. Detune the core of the balanced modulator output transformer (T2) so that the 3 millivolts of audio will produce 70 to 80 volts RF at the transmitter output (70 to 80 on the panel meter).

9.11. AUDIO AND RF PHASE SHIFT ADJUSTMENTS (UNWANTED SIDEBAND REJECTION).

The AUDIO \emptyset BAL (R65), AUDIO BAL (R70), RF \emptyset L (L1) and RF \emptyset C (C6) controls determine the degree of suppression of the unwanted sideband. These adjustments are made at one frequency and hold for all other output frequencies of the transmitter. Once properly set, they should require no further adjustment for extended periods of time.

Re-alignment is necessary under the following conditions: replacement of either of the balanced modulator tubes, V3 or V4, or the audio modulator tube, V5; aging of the associated tubes; service or replacement of components in the respective circuits.

A good vacuum tube voltmeter and oscilloscope connected to the transmitter output are an aid in making these adjustments, but are not to be considered as absolutely necessary for alignment.

A satisfactory alignment indication can be obtained by using only an S-meter equipped, communications type receiver. A low-level source of 1000 CPS sine wave audio is also required.

For complete understanding of the following alignment procedure, reference should be made to figure 16 of this manual.

1. Tune transmitter as for DSB operation on 80 meters (3900 KC) into a dummy load.
2. Set OPERATION switch to STBY.
3. Set FUNCTION switch to USB.
4. Set MIC GAIN control to zero.
5. Allow sufficient time for transmitter to stabilize (approximately 1/2 hour).
6. Set OPERATION switch to MOX.
7. Set CARRIER BALANCE controls for maximum carrier suppression (minimum indication on RF output meter).

IMPORTANT

Carrier balance should be checked periodically during the alignment procedure.

8. Connect source of 1000 CPS sine wave audio to MIC input socket.
9. With MIC GAIN control set to 8 on the dial, adjust audio source voltage to produce approximately 2/3 full transmitter output (60 on panel meter).

NOTE

With audio oscillators that produce a comparatively large output voltage, it may be necessary to insert an attenuator in the audio input lead to prevent overload saturation of the input audio stages.

10. Tune the receiver, set to the narrowest selectivity position with the BFO off, for the maximum S-meter reading at the transmitted sideband frequency (see figure 16A). Adjust the antenna coupling and/or the receiver RF gain control to prevent receiver saturation while maintaining a good S-meter indication.

11. Set the HT-44 FUNCTION switch to LSB. There should be a noticeable reduction in the receiver S-meter reading. As shown in figure 16D, the receiver is now tuned to the unwanted sideband frequency.

In cases of extreme mis-alignment of the phase shift controls, RFØL, RFØC, AUDIO Ø BAL, and AUDIO BAL, it is difficult to locate the wanted and unwanted sidebands on the basis of signal strength, since the unwanted sideband may be equal or even greater in amplitude than the wanted sideband. Under these conditions, before proceeding with alignment, it is necessary to determine the sideband relationship to the suppressed carrier. To accomplish this, proceed as follows:

- (a) Set the HT-44 FUNCTION switch to CAL.
- (b) Tune the receiver to "zero in" (peak reading on S-meter) on the transmitter frequency. Adjust the CAL LEVEL control as necessary to provide adequate coupling to the receiver.
- (c) Set the HT-44 FUNCTION switch to USB (transmitter modulated with 1000 CPS audio tone as previously explained).
- (d) Tune the receiver, set to its narrowest selectivity position, to the wanted sideband frequency. This will now be the first S-meter peak found by tuning the receiver higher (1 KC) in frequency from the carrier setting.
- (e) Set the HT-44 FUNCTION switch to LSB. The receiver is now tuned to the unwanted sideband frequency.

12. Starting from the extreme counter-clockwise end, adjust the AUDIO Ø BAL control (R65) for maximum S-meter null (i.e., lowest reading).

13. Adjust the AUDIO BAL control (R70) for maximum S-meter null.

14. Alternately adjust the RFØL (L1) and RFØC (C6) for maximum S-meter null.

15. Readjust the AUDIO Ø BAL and AUDIO BAL controls for maximum null. Only a very slight adjustment should be required.

16. Steps 14 and 15 should be repeated until no further reduction in the S-meter reading can be obtained. Note the S-meter reading for future reference.

17. Retune receiver to the wanted sideband frequency (LSB).

18. Set the HT-44 FUNCTION switch to USB. Note S-meter reduction. Compare this reading to that obtained on the other sideband.

19. A compromise of the low reading obtained on either sideband should be made by setting the AUDIO Ø BAL control to split the difference between them.

If an oscilloscope is available, this compromise setting can be determined by observing the output waveform as the FUNCTION switch is set alternately between USB and LSB. Proper setting of the AUDIO Ø BAL control is evidenced by essentially equal ripple appearing on either sideband pattern.

20. Readjust RFØL and RFØC for maximum S-meter null. Note the S-meter reading for future reference.

21. Retune RECEIVER to wanted sideband (USB) frequency.

22. Set the HT-44 FUNCTION switch to LSB. Note this S-meter reading.

23. The S-meter differences between steps 20 and 22 should be compromised as in step 19.

24. Repeat steps 14 through 23 until no further compromise setting is necessary with RFØL and RFØC set for maximum null on either sideband. The oscilloscope representation of this condition will be minimum ripple on either sideband consistent with equal ripple amplitude.

SECTION X

PS-150-120 POWER SUPPLY

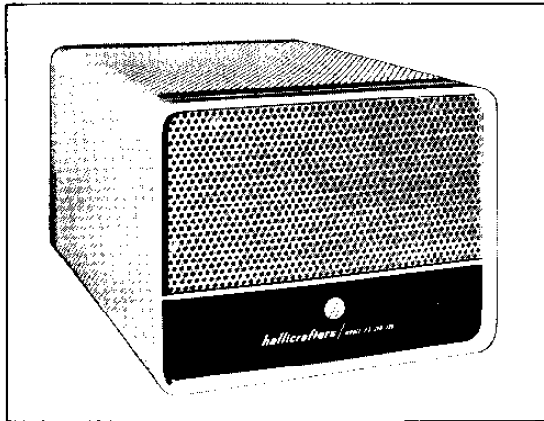

Figure 17. Hallicrafters' Model PS-150-120 Power Supply.

DP2-017846

10.1. SPECIFICATIONS.

INPUT VOLTAGE

105-125 volts, 50/60 cycles AC.

OUTPUT VOLTAGES (Maximum Ratings)

12.6 VAC at 4.5 amperes.
+250 VDC at 175 milliamperes.
+525 VDC at 380 milliamperes.
-125 VDC at 6.5 milliamperes (variable with control).

SPEAKER

Four by six-inch permanent-magnet type with 3.2-ohm voice coil.

CONTROL SWITCHING

Remote.

RECTIFIERS

Four type 1N3487, and one type 1N3194.

OVERALL DIMENSIONS (HWD)

6-1/4 x 7-1/2 x 10 inches.

NET WEIGHT

22 pounds.

SHIPPING WEIGHT

28-1/2 pounds (approximately).

CAUTION

The HT-44 OPERATION switch should be in the OFF position before connecting the PS-150-120 Power Supply.

10.2. GENERAL.

The PS-150-120 supply is a complete, self-contained unit designed to supply all necessary operating voltages for the HT-44, SR-150, and SR-160 series of equipments, when operated from a nominal 117-volt, AC source. The power supply is remotely switched and all connections, including the built-in speaker connections, are made through a 12-pin power plug and cable.

The PS-150-120 operates from a 105 to 125-volt, 50/60-cycle AC source.

As previously mentioned, a built-in speaker is provided. This speaker is of the permanent-magnet type and has a voice-coil impedance of 3.2 ohms.

Five solid-state rectifiers are used in conjunction with heavy-duty components to give cool, reliable, trouble-free operation.

A BIAS ADJ control is provided on the rear-chassis apron to satisfy the bias requirements of the transmitter.

Two tip jacks are provided on the chassis for measuring the high-voltage plate current with an external meter.

10.3. UNPACKING.

After unpacking the PS-150-120, examine it closely for any possible damage that may have occurred in transit. Should any sign of damage be apparent, file a claim immediately with the carrier stating the extent of damage. Carefully check all labels and tags before removing or destroying them.

To gain access to the power cable, remove the rear cover and pull the cable out. The cover need not be replaced until the bias adjustment has been made.

10.4. LOCATION.

This unit should be placed in a location that provides adequate space around it to permit free circulation of air through the cabinet openings. Avoid excessively warm locations such as those near radiators and heating vents.

WARNING

LETHAL HIGH VOLTAGE IS PRESENT WITHIN THIS EQUIPMENT. BE CAREFUL WHEN INSTALLING THE UNIT, WHEN MAKING BIAS ADJUSTMENTS, AND WHEN PERFORMING CHECKS UNDER THE CHASSIS.

Bias adjustment must be performed, per paragraph 9-3 of this manual, before operating the HT-44 Transmitter/Exciter.

Replace three-ampere line fuse with four-ampere fuse supplied with the HT-44 transmitter.

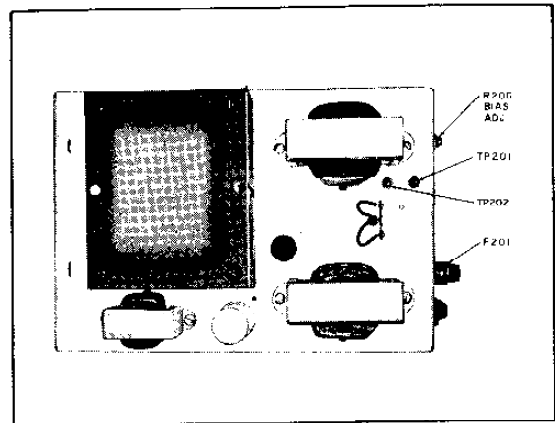

092-017845

Figure 18. Top View of the PS-150-120 Power Supply Chassis.

PS-150-120 PARTS LIST

SCHMATIC SYMBOL	DESCRIPTION	HALLICRAFTERS PART NUMBER	SCHMATIC SYMBOL	DESCRIPTION	HALLICRAFTERS PART NUMBER
C201,202	Capacitor, 0.01 μ F, 1400V, Ceramic Disc	047-200752	R205	Resistor, 22K Ohms, 10%, 1 watt, Carbon	451-352223
C203	Capacitor, 0.001 μ F, 3000V, Ceramic Disc	047-100397	R206	Resistor, Variable, 10K Ohms, 20%, 3/4 watt, Bias Adj.	025-002330
C204A&B	Capacitor, 2 x 30 μ F, 350V, Electrolytic	045-000902	R207	Resistor, 10 Ohms, 5%, 1 watt, Carbon	451-351100
C205,206	Capacitor, 80 μ F, 450V, Electrolytic	045-000369	T201	Transformer, Power	052-001007
C207,208	Capacitor, 20 μ F, 250V, Electrolytic	045-000903	TP201	Tip Jack, Red	036-000304
CR201,202, 203,204	Diode, Silicon, Type 1N3487	027-000314	TP202	Tip Jack, Blue	036-000307
CR205	Diode, 1N3194	019-002769		Baffle Board	078-001711
F201	*Fuse, 3 Amperes, 125 Volts, 3AG (Slow Blow)	039-100390		Baffle, Felt	014-000476
J201	Connector, Power (12-pin)	010-002613		Cabinet	066-003437
L201	Choke, Filter	056-000595		Cable (9-conductor)	087-007657
L202	Choke, Filter	056-000585		Cable Assembly	087-007648
L203	Choke, Filter	056-000501		Cable Clamp	076-202746
R201,202	Resistor, 15K Ohms, 10%, 10 watts, Wire Wound	445-032153		Foot, Plastic (4)	016-201072
R203	Resistor, 100 Ohms, 10%, 1/2 watt, Carbon	451-252101		Front Panel	068-001263
R204	Resistor, 4700 Ohms, 10%, 2 watts, Carbon	451-652472		Fuse Holder	006-200837
				Line Cord	087-104690
				Lock, Line Cord	078-100953
				Medallion, Hallicrafters H	007-000850
				Rear Panel	068-001404
				Speaker, 4 x 6 inch PM, 3.2 Ohms	085-000218

* Replace with 4 AMP slo-blo fuse (039-100448) when used with the HT-44

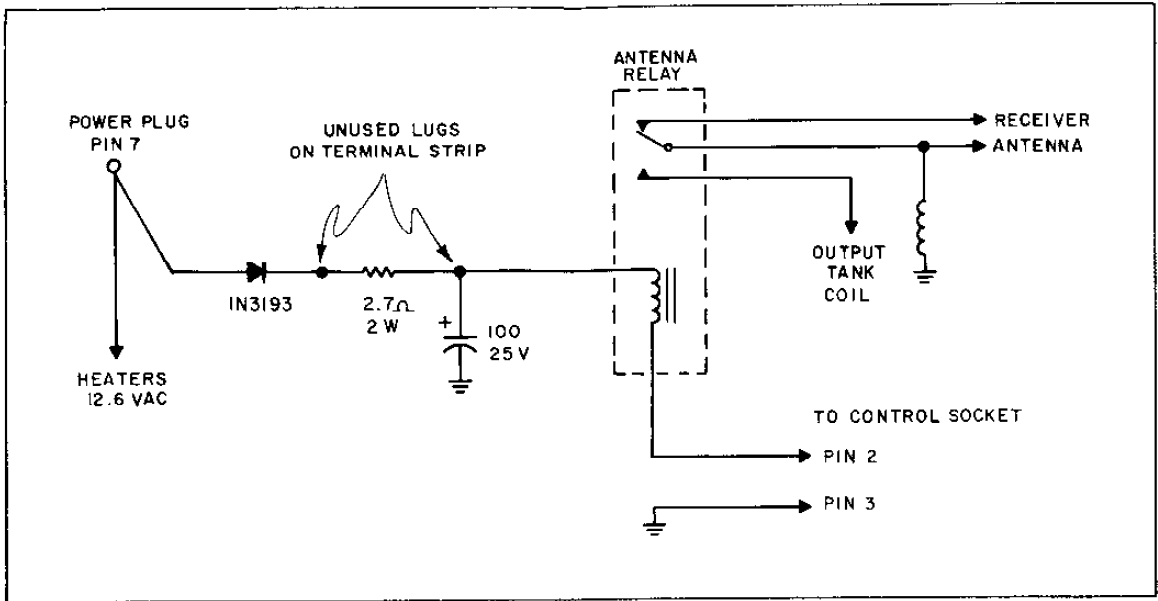

Figure 20. Partial Schematic, Showing Relay Installation.

156-002724

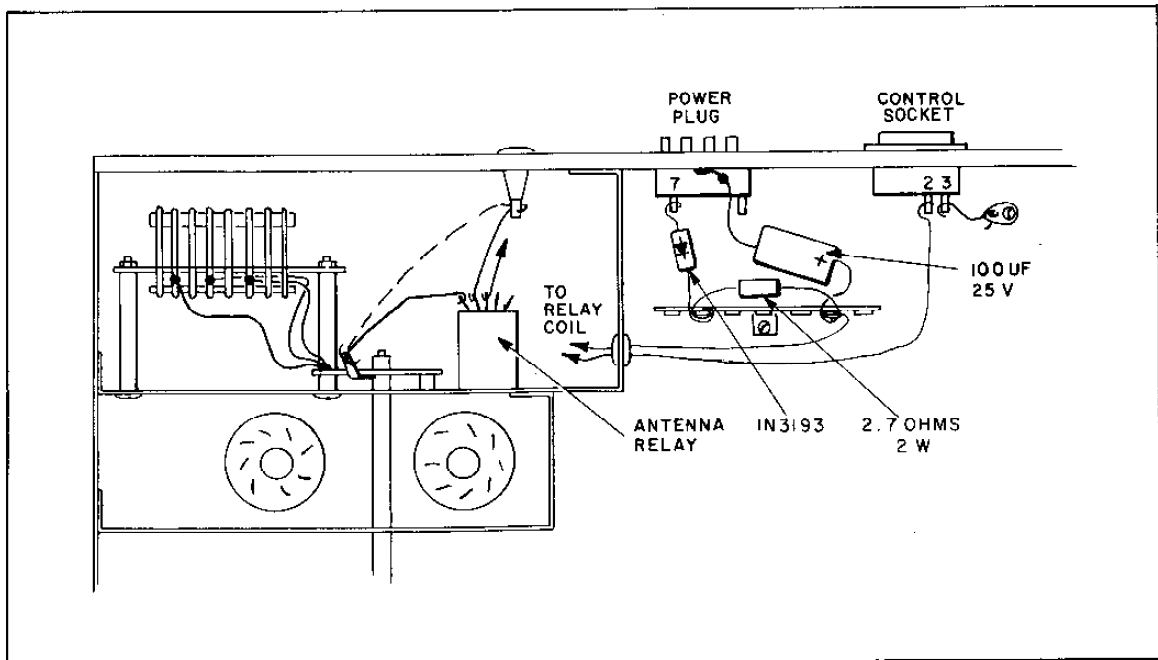
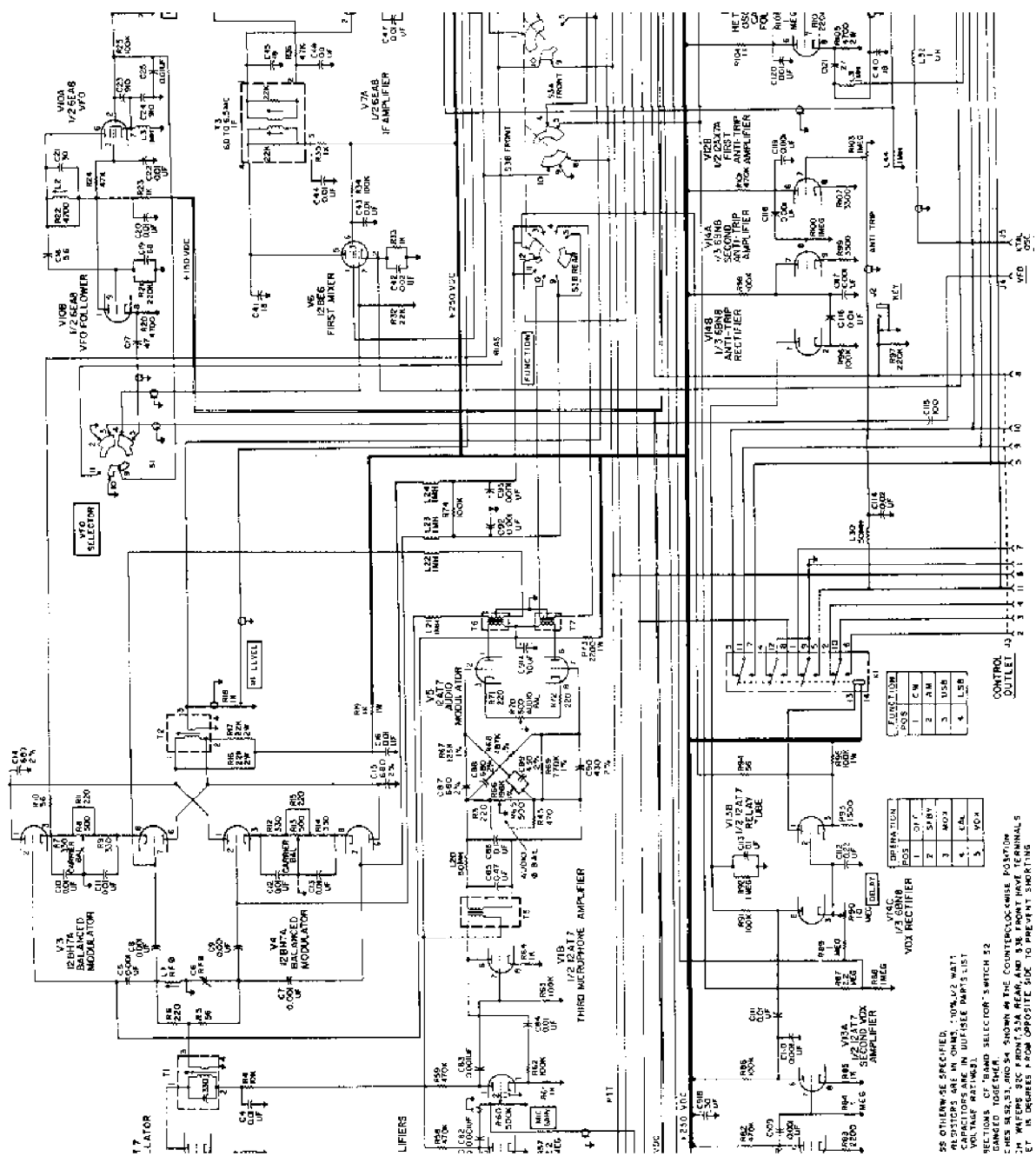

Figure 21. Partial View of HT-44, Showing Relay Installation.

156-002720



OPERATION	
1	OFF
2	AM
3	MOD
4	CL
5	VOX

FUNCTION	
1	CW
2	AM
3	LSB
4	LSB

25 OTHERWISE SPECIFIED.
 RESISTORS ARE IN OHMS, 10% ± 2 WATT
 CAPACITORS ARE IN MICROFARAD UNLESS
 OTHERWISE SPECIFIED.
 CONNECTIONS OF TRANSFORMER SHOULD BE
 CHECKED TOGETHER.
 CHES 12BE6, 12BE6B, AND 12BE6C SHOWN IN THE COUNTERCLOCKWISE POSITION
 IN WAFERS SEC 4 FROM 25A TO 25C SHOULD HAVE TERMINAL 5
 CONNECTED TO GROUND. CHES 12BE6 AND 12BE6B SHOULD BE
 EXACTLY THE SAME VALUE SHOWN IN REPLACEMENT LIST
 EXCEPT USE SAME VALUE AS PART NUMBER.

